

iCarsoft

CR MAX

User Manual

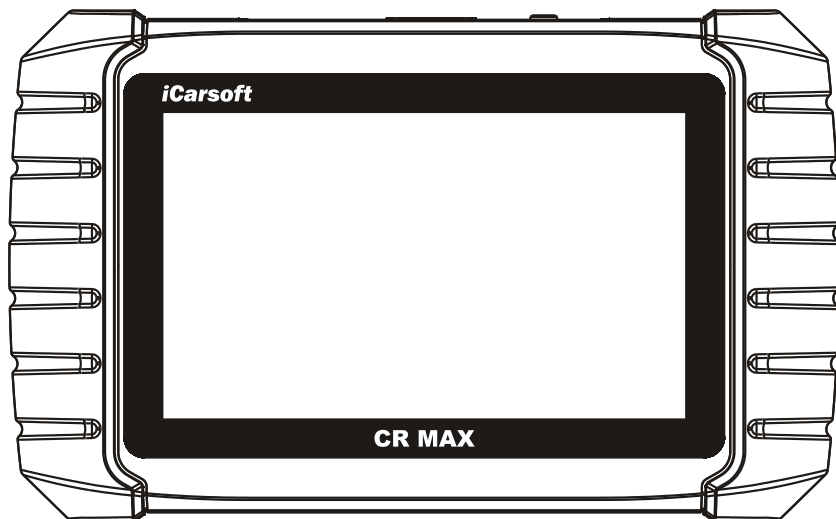

PROFESSIONAL . FAST . SMART . POWERFUL

Trademarks

iCarsoft, CR MAX and CR MAX BT are trademarks of iCarsoft Intelligent Technology Corp., Ltd., registered in the United States and other countries. All other marks are trademarks or registered trademarks of their respective holders.

Copyright Information

No part of this manual may be reproduced, stored in a retrieval system or transmitted, in any form or by any means, electronic, mechanical, photocopying, recording, or otherwise without the prior written permission of iCarsoft.

Disclaimer of Warranties and Limitation of Liabilities

All information, specifications and illustrations in this manual are based on the latest information available at the time of printing.

iCarsoft reserves the right to make changes at any time without notice. While information of this manual has been carefully checked for accuracy, no guarantee is given for the completeness and correctness of the contents, including but not limited to the product specifications, functions, and illustrations.

iCarsoft will not be liable for any direct, special, incidental, indirect damages or any economic consequential damages (including the loss of profits).

IMPORTANT

Before operating or maintaining this unit, please read this manual carefully, paying extra attention to the safety warnings and precautions.

For Services and Support



[Http://www.icarsoft.us](http://www.icarsoft.us)
[Http://www.icarsoft.com](http://www.icarsoft.com)



Support@icarsoft.us

For technical assistance in all other markets, please contact your local

selling agent.

Safety Information

For your own safety and the safety of others, and to prevent damage to the device and vehicles upon which it is used, it is important that the safety instructions presented throughout this manual be read and understood by all persons operating or coming into contact with the device.

There are various procedures, techniques, tools, and parts for servicing vehicles, as well as in the skill of the person doing the work. Because of the vast number of test applications and variations in the products that can be tested with this equipment, we cannot possibly anticipate or provide advice or safety messages to cover every circumstance. It is the automotive technician's responsibility to be knowledgeable of the system being tested. It is crucial to use proper service methods and test procedures. It is essential to perform tests in an appropriate and acceptable manner that does not endanger your safety, the safety of others in the work area, the device being used, or the vehicle being tested.

Before using the device, always refer to and follow the safety messages and applicable test procedures provided by the manufacturer of the vehicle or equipment being tested. Use the device only as described in this manual. Read, understand, and follow all safety messages and instructions in this manual.

Safety Messages

Safety messages are provided to help prevent personal injury and equipment damage. All safety messages are introduced by a signal word indicating the hazard level.

DANGER

Indicates an imminently hazardous situation which, if not avoided, will result in death or serious injury to the operator or to bystanders.

WARNING

Indicates a potentially hazardous situation which, if not avoided, could result in death or serious injury to the operator or to bystanders.

Safety Instructions

The safety messages herein cover situations iCarsoft is aware of. iCarsoft cannot know, evaluate or advise you as to all of the possible hazards. You must be certain that any condition or service procedure encountered does not jeopardize your personal safety.

DANGER

When an engine is operating, keep the service area WELL VENTILATED or attach a building exhaust removal system to the engine exhaust system. Engines produce carbon monoxide, an odorless, poisonous gas that causes slower reaction time and can lead to serious personal injury or loss of life.

SAFETY WARNINGS

- Always perform automotive testing in a safe environment.
- Wear safety eye protection that meets ANSI standards.
- Keep clothing, hair, hands, tools, test equipment, etc. away from all moving or hot engine parts.
- Operate the vehicle in a well ventilated work area, for exhaust gases are poisonous.
- Put the transmission in PARK (for automatic transmission) or NEUTRAL (for manual transmission) and make sure the parking brake is engaged.
- Put blocks in front of the drive wheels and never leave the vehicle unattended while testing.
- Be extra cautious when working around the ignition coil, distributor cap, ignition wires and spark plugs. These components create hazardous voltages when the engine is running.

- Keep a fire extinguisher suitable for gasoline, chemical, and electrical fires nearby.
- Do not connect or disconnect any test equipment while the ignition is on or the engine is running.
- Keep the test equipment dry, clean, free from oil, water or grease. Use a mild detergent on a clean cloth to clean the outside of the equipment as necessary.
- Do not drive the vehicle and operate the test equipment at the same time. Any distraction may cause an accident.
- Refer to the service manual for the vehicle being serviced and adhere to all diagnostic procedures and precautions. Failure to do so may result in personal injury or damage to the test equipment.
- To avoid damaging the test equipment or generating false data, make sure the vehicle battery is fully charged and the connection to the vehicle DLC is clean and secure.
- Do not place the test equipment on the distributor of the vehicle. Strong electro-magnetic interference can damage the equipment.

CONTENTS

1	Using this Manual	1
1.1	Conventions	1
1.1.1	Bold Text	1
1.1.2	Notes and Important Messages	1
1.1.3	Hyperlink	2
1.1.4	Illustrations	2
2	General Introduction	3
2.1	CR MAX Display Tablet	3
2.1.1	Functional Description	3
2.1.2	Power Sources	4
2.1.3	Technical Specifications	5
2.2	Accessory Kit	7
2.2.1	Main Cable	7
2.2.2	Other Accessories	7
3	Getting Started	8
3.1	Powering Up	8
3.1.1	Application Buttons	9
3.1.2	Locator and Navigation Buttons	10
3.2	Powering Down	11
3.2.1	Reboot System	12
4	Diagnostics	13
4.1	Getting Started	13
4.1.1	Vehicle Menu Layout	13
4.2	Vehicle Identification	14
4.2.1	Auto Identify	15
4.2.2	Vehicle select	18
4.3	Navigation	20
4.3.1	Diagnostics Screen Layout	20
4.3.2	Screen Messages	21
4.3.3	Making Selections	21
4.4	Diagnosis	22

4.4.1	Quick Test.....	22
4.4.2	Auto Scan.....	24
4.4.3	Control Unit.....	24
4.4.4	Quick Erase.....	25
4.4.5	Service.....	25
4.5	Diagnostic operation.....	26
4.6	Generic OBD II Operations.....	35
4.6.1	General Procedure.....	35
4.6.2	Function Descriptions.....	37
4.7	Exiting Diagnostics.....	40
5	Service Operations.....	41
5.1	ABS Bleeding.....	42
5.2	Oil Reset Service.....	45
5.3	Electronic Parking Brake (EPB) Service.....	49
5.4	Electronic Throttle Control.....	52
5.5	Injector.....	54
5.6	Steering Angle Sensor (SAS) Service.....	58
5.7	Battery Management System (BMS).....	62
5.8	DPF Service.....	68
5.9	Head Lamp.....	73
5.10	Air Suspension.....	75
5.11	TPMS programming service.....	78
5.12	Gearbox Reset.....	83
5.13	Air conditioning service.....	86
5.14	Air Filter.....	88
5.15	Fuel Pump.....	90
5.16	Engine Idle.....	92
5.17	Body stability.....	94
5.18	Door.....	97
5.19	Seat.....	99
6	User Data.....	102
6.1	Image Files.....	102
6.2	Play Back.....	103
6.3	User Manual.....	104
6.4	Training.....	105
6.5	FAQ.....	105

6.6	Data Link Connector(DLC) Location	106
7	Upgrade.....	107
8	Shop Information.....	110
8.1	Workshop Info	110
8.2	Customer Info	111
	8.2.1 Customer Notes.....	113
8.3	Vehicle History	115
	8.3.1 Historical Test Record.....	116
9	Settings.....	118
9.1	Unit.....	118
9.2	Language	119
9.3	Data log	120
9.4	WIFI.....	121
9.5	Brightness.....	121
9.6	Screen Sleep	122
9.7	Vehicle Sorted By	123
9.8	System Settings	124
9.9	Click To Restore Factory Settings	125
10	Quick Link.....	126
11	Fault Code.....	127
12	Support	128
	12.1 Account.....	128
	12.2 Data Log.....	128
13	Uninstall.....	131
14	Remote Desk.....	132
15	About.....	134
16	Maintenance and Service.....	135
	16.1 Maintenance Instructions.....	135
	16.2 Troubleshooting Checklist	136

16.3	About Battery Usage	137
16.4	Service Procedures	138
16.4.1	<i>Technical Support</i>	138
16.4.2	<i>Repair Service</i>	138
16.4.3	<i>Other Services</i>	139
17	Compliance Information	140
18	Warranty	143
18.1	Limited One Year Warranty	143

1 Using this Manual

This manual contains device usage instructions.

Some illustrations shown in this manual may contain modules and optional equipment that are not included in your system.

1.1 Conventions

The following conventions are used.

1.1.1 Bold Text

Bold text is used to highlight selectable items such as buttons and menu options.

Example:

- Tap **OK**.

1.1.2 Notes and Important Messages

Notes

A **NOTE** provides helpful information such as additional explanations, tips, and comments.

Example:

NOTE

New batteries reach full capacity after approximately 3 to 5 charging and discharging cycles.

Important

IMPORTANT indicates a situation which, if not avoided, may result in damage to the tablet or vehicle.

Example:

! IMPORTANT

Keep the cable away from heat, oil, sharp edges and moving parts.
Replace damaged cables immediately.

1.1.3 Hyperlink

Hyperlinks, or links, that take you to other related articles, procedures, and illustrations are available in electronic documents. Blue italic text indicates a selectable hyperlink and blue underlined text indicates a website link or an email address link.

1.1.4 Illustrations

Illustrations used in this manual are samples, the actual testing screen may vary for each vehicle being tested. Observe the menu titles and on-screen instructions to make correct option selection.

2 General Introduction

When it comes to ultra-portability, CR MAX is your perfect companion. Installed with a fast quad-core processor, CR MAX offers maximum convenience and swift diagnosis. The intuitive user screen makes using the device effortless through a 7-inch LCD touchscreen that displays at 1024 x 600 quality. Together with the ability to quickly read and clear DTCs for all available modules of the majority of the makes and models on the market, CR MAX provides you with superior special functions, including Oil Reset, EPB (Electronic Parking Brake), SAS (Steering Angle Sensor), BMS (Battery Management System), DPF (Diesel Particulate Filter), ABS Bleeding, ETC (Electronic Throttle Control) and Injector.

This manual describes the construction and operation of the device and how it works to deliver diagnostic solutions.

2.1 CR MAX Display Tablet

2.1.1 Functional Description

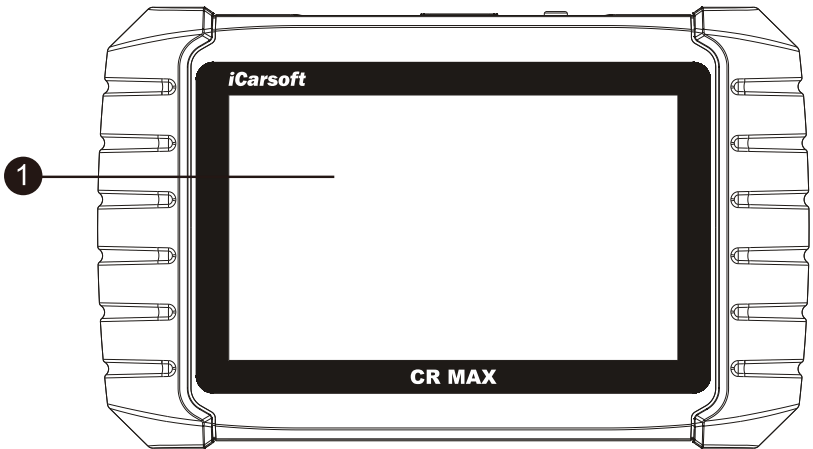

Figure 2-1 Display Tablet Front View

1. 7.0" LCD Capacitive Touchscreen

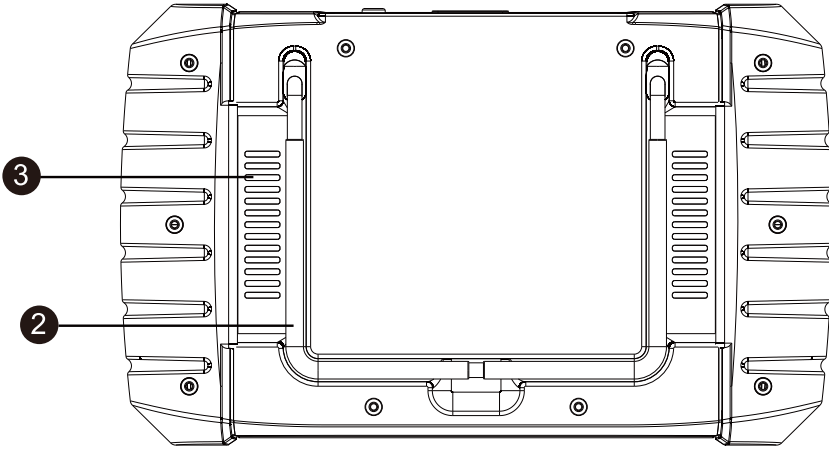

Figure 2-2 CR MAX Display Tablet Back View

2. Collapsible Stand – extends from the back to allow hands-free viewing of the Display Tablet.

3. Heat Sink or Speaker

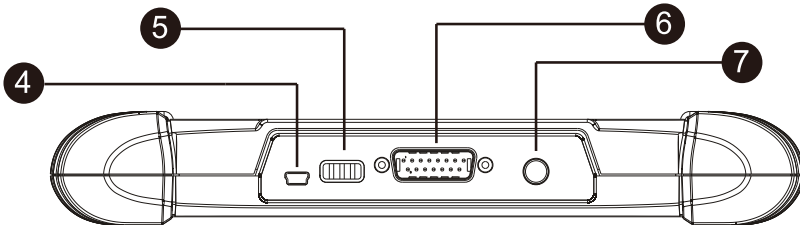

Figure 2-3 CR MAX Display Tablet Top View

4. Mini USB OTG Port

5. USB Host (Wireless has this interface, wired does not have this interface)

6. DB15-Pin Port – connects the main cable. (Wired has this interface, wireless does not have this interface)

7. Lock/Power Button – long press button to turn tablet off and on. Quick press button to lock screen.

2.1.2 Power Sources

The Display Tablet can receive power from any of the following sources:

- Internal Battery Pack
- Vehicle Power
- External Power Supply

Internal Battery Pack

The Display Tablet can be powered with the internal rechargeable battery, which if fully charged can provide sufficient power for about 4.5 hours of continuous operation.

Vehicle Power

When the Display Tablet is connected to the test vehicle via the main cable, the Display Tablet automatically receives power from the vehicle.

External Power Supply

The Display Tablet can be powered from a wall socket using the mini USB cable and USB external power adapter. The external power supply also charges the internal battery pack.

2.1.3 Technical Specifications

Table 2-1 Specifications

Item	Description
Recommended Use	Indoor
Operating System	Android 8.1.0
Processor	4Nuclear 1.3 GHz
Memory	16GB
Display	7-inch LCD capacitive touchscreen with 1024x600 resolution

Connectivity	<ul style="list-style-type: none"> • Mini USB 2.0 • USB 2.0 • Wi-Fi • Bluetooth • OBD II
Body Color	Black
Audio Input/ Output	<ul style="list-style-type: none"> • Input: N/A • Output: Buzzer & Speaker
Power and Battery	<ul style="list-style-type: none"> • OBD DLC Voltage Range:9-18V • 3.7V/5000mAh lithium-polymer battery • Charges via 5 VDC power supply
Tested Battery Life	Around 5 hours of continuous use
Battery Charging Input	5 V/2 A
Power Consumption	500mA (LCD on with default brightness, Wi-Fi on) @3.7 V
Operating Temp.	0 to 40°C (32 to 104°F)
Storage Temp.	-20 to 70°C (-4 to 158°F)
Operating Humidity	5% - 95% non-condensing
Dimensions (W x H x D)	240.0mm*150.0mm*35.0mm
Net Weight	750 g
Supported Automotive Protocols	ISO9141-2, ISO14230-2,ISO15765, K/L-Line, Flashing Code, SAE-J1850 VPW, SAE-J1850 PWM, ISO11898 (Highspeed, Middlespeed, Lowspeed and Singlewire CAN, fault-tolerant CAN), SAE J2610,GM UART,UART Echo Byte Protocol, Honda Diag-H Protocol, TP2.0, TP1.6

2.2 Accessory Kit

2.2.1 Main Cable

The Main Cable connects the Display Tablet to the vehicle's data link connector (DLC).

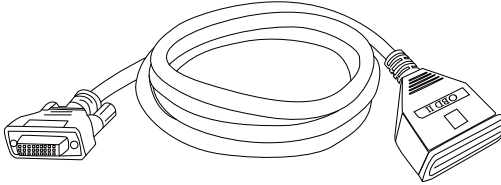

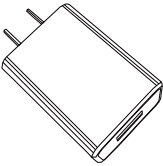
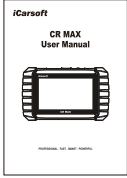
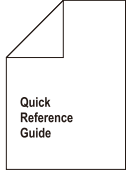

Figure 2-4 Main Cable

2.2.2 Other Accessories

	<p>Mini USB Cable Connects the Display Tablet to the PC or DC external power adapter.</p>
	<p>USB External Power Adapter Together with the mini USB cable, connects the Display Tablet to the external DC power port for power supply.</p>
	<p>User Manual Tool operations instructions.</p>
	<p>Quick Guide Device connection and product unpacking list, product description, etc.</p>

3 Getting Started

Ensure the tablet is sufficiently charged or is connected to the external power supply (see *Power Sources* on page 4-5).

NOTE

The images and illustrations depicted in this manual may differ from the actual ones.

3.1 Powering Up

Press the Lock/Power button on the top right side of the tablet to power the unit on. The system boots up, and displays the lock screen. Slide the lock icon up and down to access the CR Max job menu.

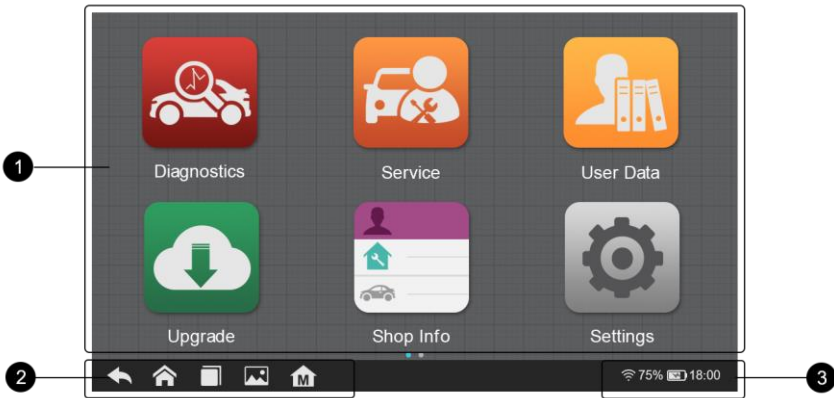

Figure 3-1 Sample CR MAX Job Menu

1. Application Buttons
2. Navigation Buttons
3. Status Icons

NOTE

The tablet screen is locked by default upon startup. It is recommended to lock the screen when not in use to protect the information in the system





and conserve the power.







Almost all operations on the tablet are controlled through the touchscreen. The touchscreen navigation is menu driven, which allows you to quickly locate the test procedure, or data that you need, through a series of choices and questions. Detailed descriptions of the menu structures are found in the chapters for each application.

3.1.1 Application Buttons

The tablet below briefly describes each of the applications in the CR MAX system.

Table 3-1 Applications







Button	Name	Description
	Diagnostics	Accesses diagnostic functions menu. See Diagnostics Operations on page 13.
	Service	Accesses special functions menu. See Service Operations on page 41.
	User Data	Accesses the organization system for saved data files. See User Data Operations on page 102.
	Upgrade	Checks for the latest update available for the CR MAX system, and performs updates. See Upgrade Operations on page 106.
	Shop Information	Accesses the workshop information service program, including customer information records and test vehicle history records. See Shop Manager Operations on page 110.

Button	Name	Description
	Settings	Accesses CR MAX system settings menu and general tablet menu. See Settings Operations on page 118.
	Quick Link	Provides associated website bookmarks to allow quick access to product update, service, support and other information. See Quick Link Operations on page 126.
	Fault Code	Allows the user to query the fault information of the vehicle model according to the fault code. See Fault Code Operations on page 127.
	Support	Launches the Support platform which synchronizes iCarsoft's on-line service base station with the CR MAX tablet. See Support Operations on page 128.
	Uninstall	Manage the firmware applications installed on the CR MAX Diagnostics System. See Uninstall Operations on page 131.
	Remote desk	Configures the unit to receive remote support using the TeamViewer application program. See Remote Desk Operations on page 132.
	About	Access CR MAX system information about the machine. See About Operations on page 134.

3.1.2 Locator and Navigation Buttons

Operations of the Navigation buttons at the bottom of the screen are described in the table below:

Table 3-2 Locator and Navigation Buttons

Button	Name	Description
	Locator	Indicates the location of the screen. Swipe the screen left or right to view the previous or next screen.
	Back	Returns to the previous screen.
	Android Home	Returns to Android System's Home screen.
	Recent Apps	Displays a list of applications that are currently in use. Tap an app icon to launch. To remove an app, swipe it to the top or bottom.
	Screenshot	Takes a screenshot when you want to save the displayed information.
	CR MAX Home	Returns to CR MAX Job Menu.

3.2 Powering Down

All vehicle communications must be terminated before shutting down the Display Tablet. A warning message displays if a shutdown is attempted while the tablet is communicating with the vehicle. Forcing a shutdown while the tablet is communicating may lead to ECM problems on some vehicles. Please exit the Diagnostics application before shutting off the tablet.

➤ **To power down the display tablet**

1. Long press the Lock/Power Button.

2. Tap Power off option.
3. Tap OK, the tablet will turn off in a few seconds.

3.2.1 Reboot System

In case of system crash, long press the Lock/Power button and tap Reboot option to restart the system.

4 Diagnostics

The Diagnostics application can access the electronic control unit (ECU) of various vehicle control systems, such as engine, transmission, anti-lock brake system (ABS), airbag system (SRS) and more.

4.1 Getting Started

The Diagnostics operations require connecting the CR MAX to the test vehicle's DLC using the main cable.

4.1.1 Vehicle Menu Layout

When the tablet is properly connected to the vehicle, the platform is ready to start vehicle diagnosis. Tap on the Diagnostics application button on the CR MAX Job Menu, the Vehicle Menu then displays.

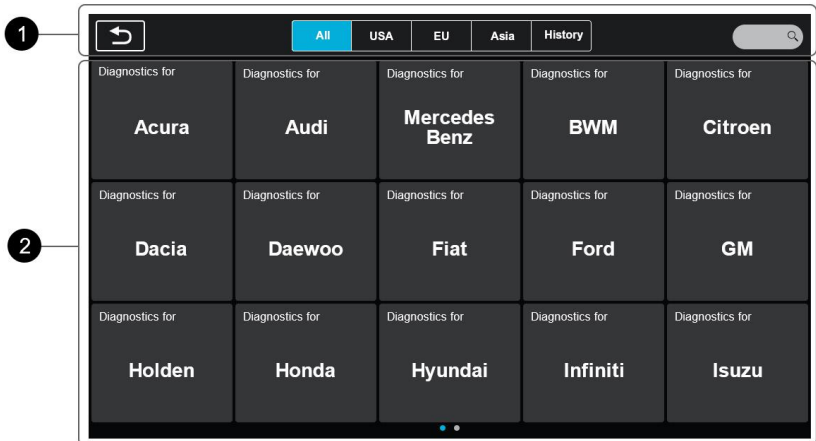









Figure 4-1 Sample Vehicle Menu

1. Top Toolbar Buttons
2. Manufacturer Buttons

Top Toolbar Buttons

The operations of the toolbar buttons at the top of the screen are listed and described in the table below:

Table 4-1 Top Toolbar Buttons

Button	Name	Description
	Home	Returns to the CR MAX Job Menu.
	All	Displays a menu of vehicle manufacturers.
	History	Displays stored test vehicle history records. Tap record to review record in detail. See <i>Vehicle History</i> on page 77.
	USA	Displays the USA vehicle menu.
	Europe	Displays the European vehicle menu.
	Asia	Displays the Asian vehicle menu.
	Search	Searches for a specific vehicle make.

Manufacturer Buttons

The vehicle manufacturer buttons display the vehicle brands currently compatible with the tool. After establishing communication with the vehicle. Tap the desired manufacturer button to start a diagnostic session.

4.2 Vehicle Identification

The CR MAX diagnostic system supports **two** methods for Vehicle Identification.

1. **Auto identify or VIN identify**
2. **Vehicle select**

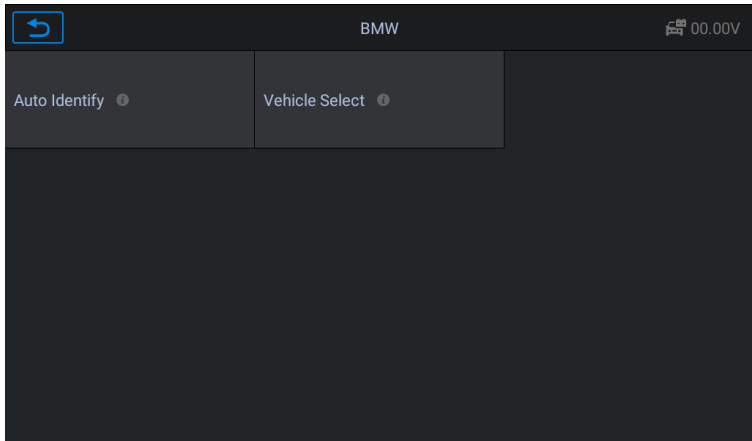

Figure 4-2 Sample Vehicle identification

Note:

Whether "auto identify" or "VIN identify" is displayed on the screen depends on the vehicle type.

4.2.1 Auto Identify

The CR MAX diagnostic system features the latest VIN-based Auto VIN Scan function to identify vehicles with just one touch, enabling the technician to quickly identify the vehicle, scan all the diagnosable ECUs on the vehicle and perform diagnostics on the selected system.

The "VIN identify" can automatically parse the car model, eliminating the cumbersome program manually input by the user.

The device diagnostic system has the latest automatic identification function based on the vehicle identification number. It stores all the diagnosable electronic control units of Scan on the vehicle and performs the diagnosis on the selected system. Perform automatic VIN recognition. For some vehicles that do not support the automatic vehicle identification number scanning function, the diagnostic tool allows you to manually enter the vehicle identification number. Recognize the VIN first. If the VIN cannot be recognized, you need to enter it manually.

- **Automatic VIN identification**

➤ To perform VIN Identify

1. Tap the **Diagnostics** application button from the CR MAX Job Menu. The Vehicle Menu displays.

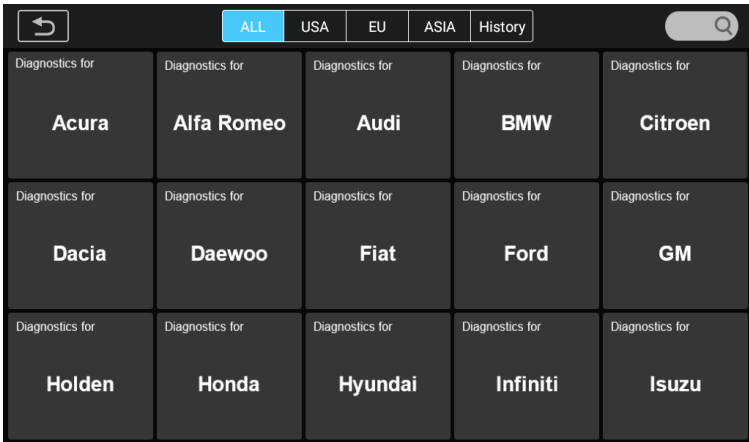

Figure 4-3 Sample VIN Identification Screen 1

2. Select **vehicle brand**. Tap the “Auto Identify”, Wait for the vehicle to communicate.

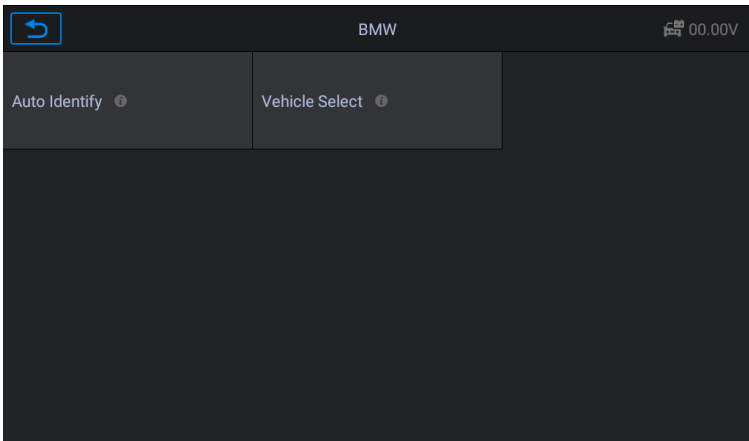

Figure 4-4 Sample VIN Identification Screen 2

3. Once the test vehicle is successfully identified, the screen will show the Vehicle information: include VIN, model code, brand etc., then tap OK to enter the diagnosis.

Vehicle Information		11.77V
VIN	LBV8V3107GMF99275	
Production Date (Month/Year)	06/2016	
Gearbox Type	Manual	
Model code	8V41	
Body	SEDAN	
Product type	P	
Brand	BMW PKW	





Figure 4-5 Sample Vehicle information Screen 3

- **Manual VIN Input**

For some vehicles that not supporting the Auto VIN Scan function, the CR MAX diagnostic system allows you to enter the vehicle VIN manually.

- **To perform Manual VIN Input**

1. Tap the **Diagnostics** application button from the CR MAX Job Menu. The Vehicle Menu displays.
2. Select **vehicle brand**. If some vehicles do not support automatic VIN code recognition, you need to enter the VIN code manually.

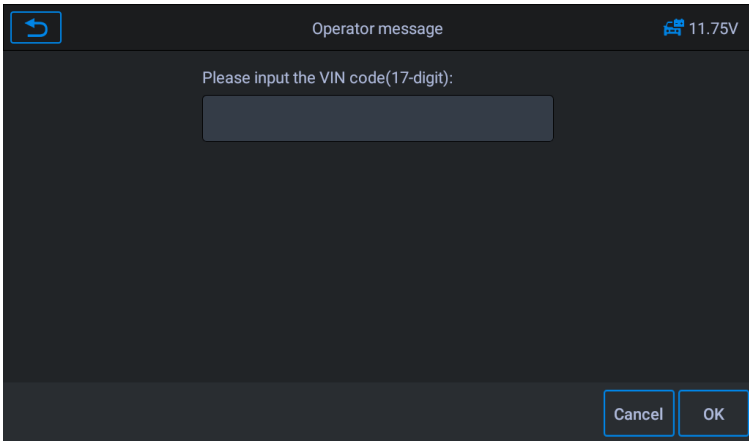

Figure 4-6 Sample VIN input Screen 1

3. Tap the input box and enter the correct VIN.

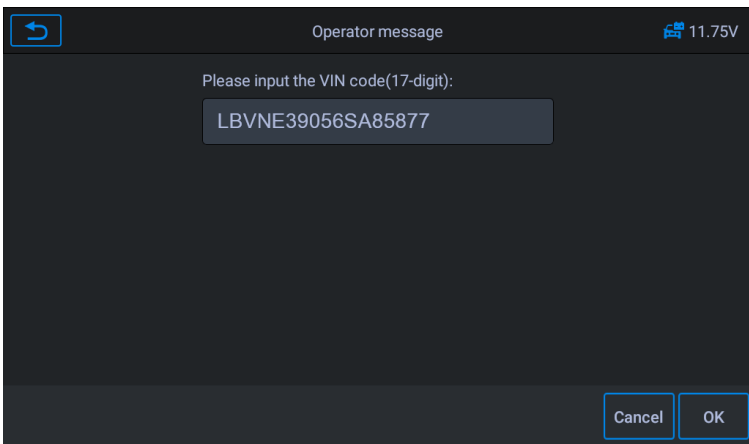

Figure 4-7 Sample VIN input Screen 2

4. Tap OK. The vehicle will be identified and the Vehicle Diagnostics screen will display.
5. Tap Cancel to exit Manual Input.

4.2.2 Vehicle select

In some cases, when the user selects the vehicle brand without performing an automatic vehicle identification number scan, the system

can provide vehicle selection to enter the vehicle diagnosis system.

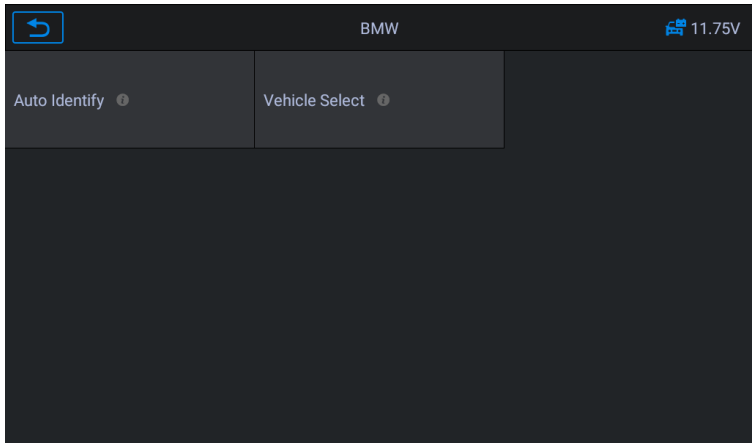

Figure 4-8 Sample Vehicle Select Screen 1

➤ **To perform Vehicle Select**

1. Tap the Diagnostics application button from the CR MAX Job Menu. The Vehicle Menu displays.
2. Tap the vehicle brand of the test vehicle.
3. Tap the "Vehicle Select" option to make a series of selections according to the on-screen prompts, select the correct vehicle model, model year, etc.,

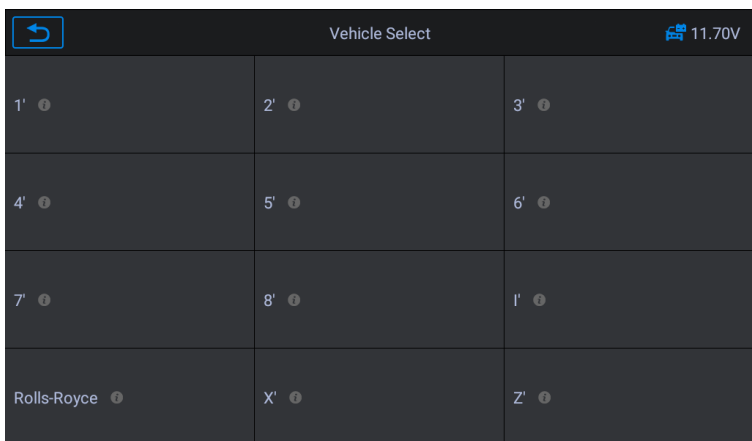

Figure 4-9 Sample Vehicle Select Screen 2

4. Select step by step according to the screen prompts, and finally enter the list of diagnosis modes.

4.3 Navigation

This section describes how to operate the Diagnostics screen and select test options.

4.3.1 Diagnostics Screen Layout

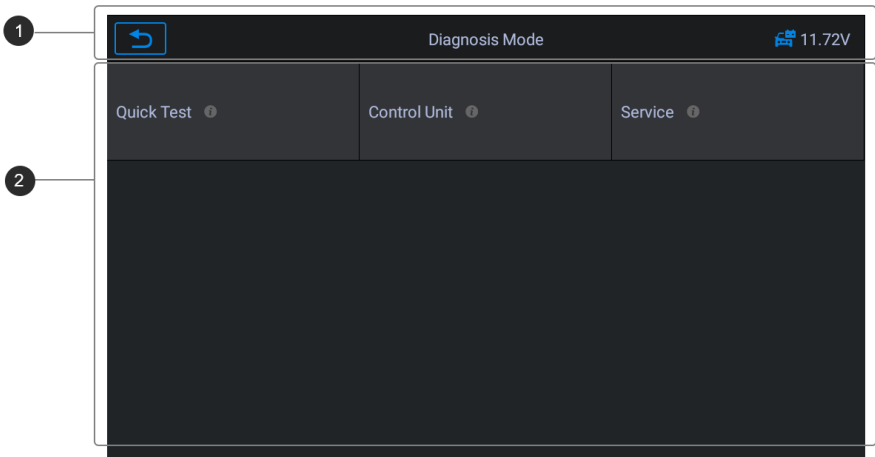

Figure 4-10 Sample Diagnosis mode Screen 1

The diagnostic screens typically include four sections.

1. Status Information Bar
2. Main Section

Status Information Bar

The Status Information Bar at the top of the Main Section displays the following items:

1. Back button – Returns to the CR MAX Job Menu.
2. Menu Title – displays the menu heading of the Main Section.

3. Voltage Icon – displays the vehicle’s voltage status.

Main Section

The main section displays the diagnostic mode of the vehicle, depending on the vehicle type; or it may vary depending on the operation stage, displaying vehicle identification selection, main menu, test data, messages, instructions and other diagnostic information.

4.3.2 Screen Messages

Screen messages appear when additional input is needed before proceeding. There are three main types of on-screen messages: Confirmation, Warning, and Error.

Confirmation Messages

This type of messages usually displays as an “Information” screen that informs you when you are about to perform an action that cannot be reversed or when an action has been initiated and your confirmation is needed to continue.

When a user-response is not required to continue, the message displays briefly.

Warning Messages

This type of messages displays a warning that a selected action may result in an irreversible change or loss of data. The typical example of this is the “Erase Codes” message.

Error Messages

Error messages display when a system or procedural error has occurred. Examples of possible errors include a disconnection or communication interruption.

4.3.3 Making Selections

The Diagnostics application is a menu driven program that presents a series of choices. As a selection is made, the next menu in the series displays. Each selection narrows the focus and leads to the desired test. Tap the screen to make menu selections.

4.4 Diagnosis

The Diagnostics application enables a data link to the electronic control system of the test vehicle for vehicle diagnosis. The application performs functional tests, retrieves vehicle diagnostic information such as trouble and event codes and live data for various vehicle control systems, such as engine, transmission, and ABS.

The scan tool provides five diagnostic modes for users to choose: Quick Test, Auto Scan, Control Unit, Service and Quick Erase. As shown in the figure below. For the quick erase mode, it is in the form of a button. Users need to go to the next layer to quickly clear the vehicle fault information recorded in the diagnosis process.

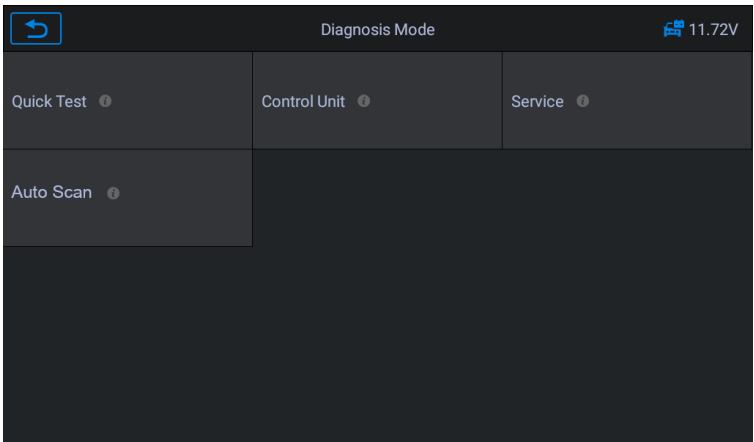

Figure 4-11 Sample Diagnosis Mode Screen 2

4.4.1 Quick Test

Scan the control unit of the whole vehicle, at the same time, the fault information of each control unit is detected to show the control unit list and fault status.

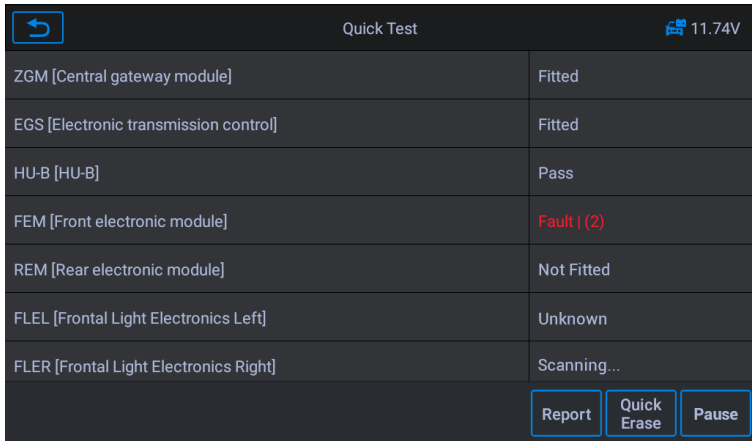

Figure 4-12 Sample Quick Test Screen

Left side – Show vehicle control unit system name.

Right side – Show vehicle control unit status.

- ◆ Fault | (2) : Indicates that the fault code is detected; 2 represents the number of faults detected.
- ◆ Pass: Indicates that the vehicle is equipped with this system and has no fault code.
- ◆ Fitted: Indicates that the vehicle is equipped with this system.
- ◆ Not Fitted: Indicates that it is detected that the vehicle is not equipped with this system.
- ◆ Unknown: Indicates that it is detected that it is unknown whether the vehicle is equipped with this system.
- ◆ Scanning: Indicates that the device is scanning the vehicle system.

[Quick Erase] – Press this button to quickly clear the fault code.

[Pause] / [Continue] – Press this button to pause or continue scanning.

[Report] – Press this button to view the fault reports generated during diagnosis.

[Back Button] – Returns to the previous screen or exits Auto Scan.

4.4.2 Auto Scan

The Smart Scan function performs a comprehensive scanning of the ECUs in the vehicle's system to locate and retrieve DTCs. Enter Smart Scan, the system will scan your vehicle's system for you.

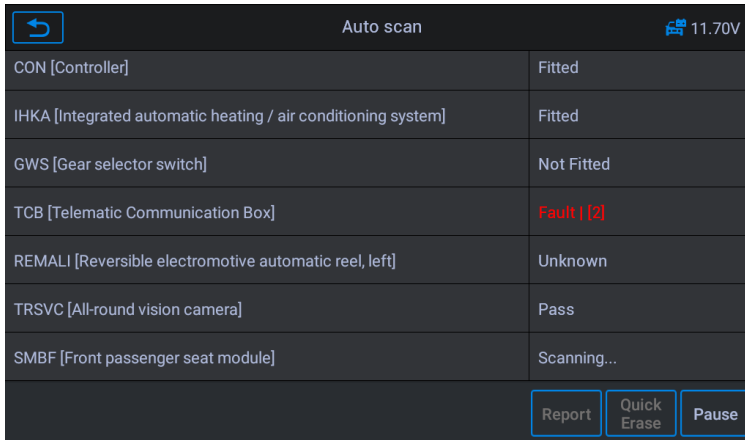

The screenshot shows the 'Auto scan' screen with a battery voltage of 11.70V. It displays a table of ECUs and their scan results. At the bottom, there are three buttons: 'Report', 'Quick Erase', and 'Pause'.

ECU Name	Scan Result
CON [Controller]	Fitted
IHKA [Integrated automatic heating / air conditioning system]	Fitted
GWS [Gear selector switch]	Not Fitted
TCB [Telematic Communication Box]	Fault [2]
REMALI [Reversible electromotive automatic reel, left]	Unknown
TRSVC [All-round vision camera]	Pass
SMBF [Front passenger seat module]	Scanning...

Figure 4-13 Sample Auto Scan Screen

4.4.3 Control Unit

This option allows you to manually locate the desired control system. According to the menu driven program, the user manually selects the specified control unit that he wants to detect, skips the whole vehicle scanning, and directly carries out the diagnosis of the specified system.

Control Unit		11.75V
ZGM [Central gateway module]	Fitted	
EGS [Electronic transmission control]	Not Fitted	
HU-B [HU-B]	Fault 2	
FEM [Front electronic module]	Unknown	
REM [Rear electronic module]	Pass	
FLEL [Frontal Light Electronics Left]	Fitted	
FLER [Frontal Light Electronics Right]	Scanning...	
		<input type="button" value="Report"/> <input type="button" value="Quick Erase"/> <input type="button" value="Pause"/>

Figure 4-14 Sample Control Unit Screen

4.4.4 Quick Erase

Quickly clear the vehicle fault information recorded in the diagnosis process.

4.4.5 Service

The vehicle diagnostic tool provides an entry from the diagnostic mode to the service function. You can easily select the service function from the diagnosis mode, without returning to the service menu for selection. For different vehicle models, the service functions are different. Select this option to perform service function and calibrating different systems, such as reset oil service lamp, EPB service, SAS service, Doors, windows and seat calibration learning and so on.

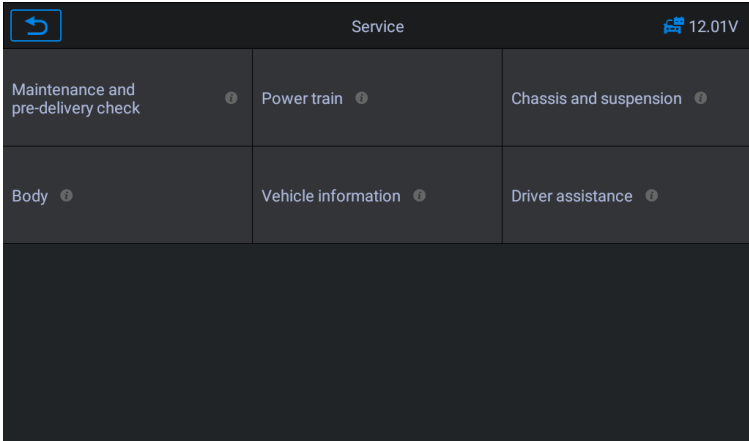

Figure 4-15 Sample Service Menu Screen

4.5 Diagnostic operation

This option allows you to manually locate a required control system for testing through a series of choices. Follow the menu driven procedures and make proper selection each time; the program will guide you to the diagnostic function menu after selections are made.

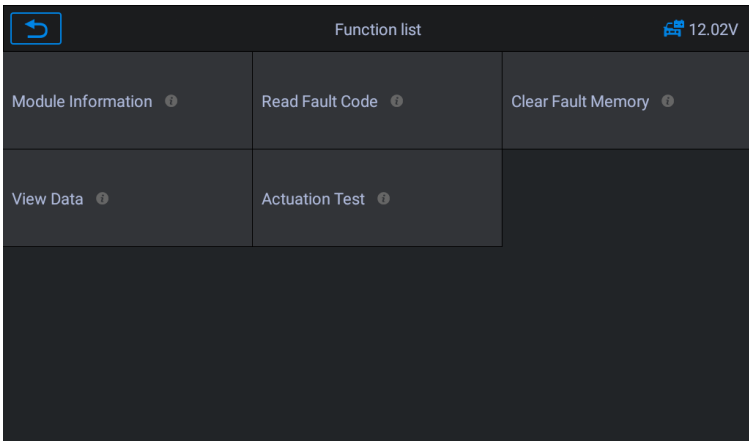

Figure 4-16 Sample Diagnostic Operation Screen

The Function Menu options vary slightly for different vehicles. The function menu may include:

1. **Module Information** – Read full electronic system module information, such as VIN, part number, version, supplier, production date of ECU.
 2. **Read fault code** – Read full electronic system module fault code, show state and description of fault code.
 3. **Clear fault Memory** – Erase full electronic system module fault code and diagnostic related freeze frame information.
 4. **View data** – Read full electronic system module live data by text value or waveform.
 5. **Actuation Test** – This function provides access to vehicle specific subsystem tests and component tests.
- **To perform a diagnostic function**
1. Establish communication with the test vehicle.
 2. Select “Diagnostic” icon.
 3. Select Vehicle Manufacturer.
 4. Select “Vehicle Select” and select vehicle model, model year, etc. according to the on-screen prompts.
 5. Select the diagnosis mode and guide the selection through the menu of any diagnosis mode to locate the required test system.
 6. Select the test to be performed on the function list.

◆ **Module Information**

This function retrieves and displays the specific information for the tested control unit, including unit type, version numbers and other specifications. Also you can save these data by press save button. The sample Module Information screen displays as below:

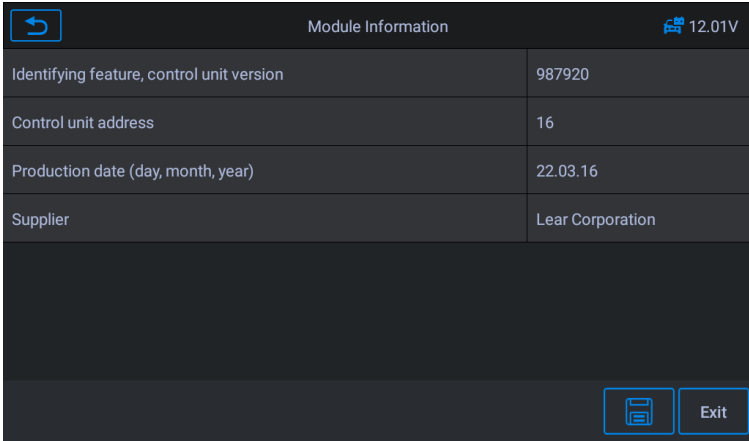

Figure 4-17 Sample Module Information Screen

◆ Read Fault Codes

This function retrieves and displays the DTCs from the vehicle's control system. The Read Codes screen varies for each vehicle being tested. On some vehicles, freeze frame data can also be retrieved for viewing. The sample Read Codes screen displays as below:

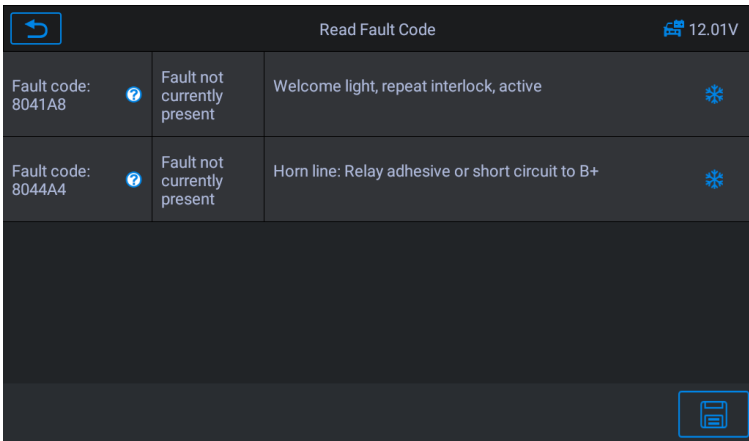



Figure 4-18 Sample Read Fault Codes Screen 1

Functional Button

- Save – tap this icon to save the information related to the fault

code

- Back – tap it to return to the previous screen or exit the function.
-  – tap this icon to view the information of the detail.

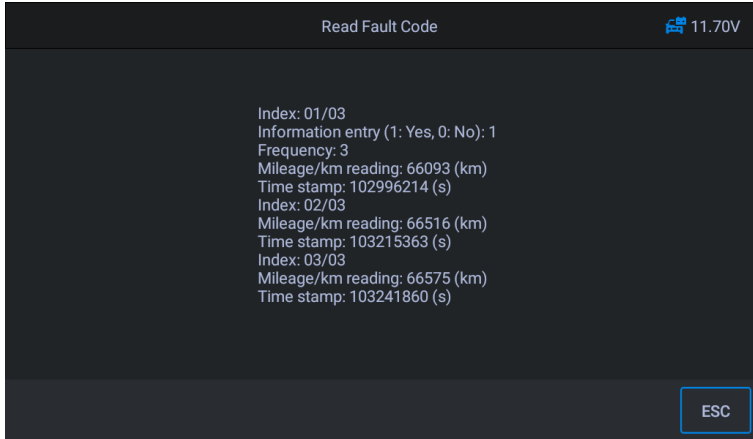



Figure 4-19 Sample Read Fault Codes Screen 2

-  – tap this icon to view the information of the freeze frame.

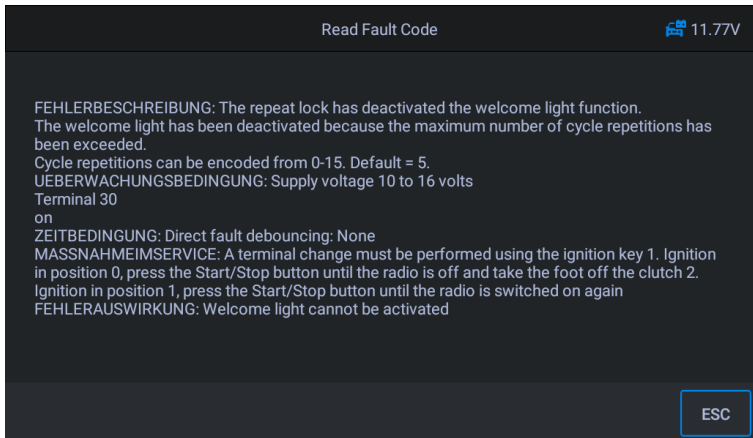

Figure 4-20 Sample Read Fault Codes Screen 3

◆ Clear Fault Codes

After reading the retrieved codes from the vehicle and certain repairs have been carried out, you can erase the codes from the vehicle using this function.

Before performing this function, make sure the vehicle's ignition key is in the ON (RUN) position with the engine off.

➤ **To erase codes**

- 1) Select the **[Clear fault code]** on the "function menu"
- 2) At this time, a warning message will appear on the screen, indicating that the fault code and frozen data information will be cleared.
 - a) Select **[OK]** to continue. After the operation is successful, an complete information will be displayed on the screen.
 - b) Select **[Cancel]** to exit.
- 3) Re-enter the **[Read fault code]** function to retrieve the fault code to ensure the successful code clearing operation.

◆ **View Data**

When this function is selected, the screen displays the data list for the selected module. The items available for any control module vary from one vehicle to another. The parameters display in the order that they are transmitted by the ECM, so expect variation between vehicles.

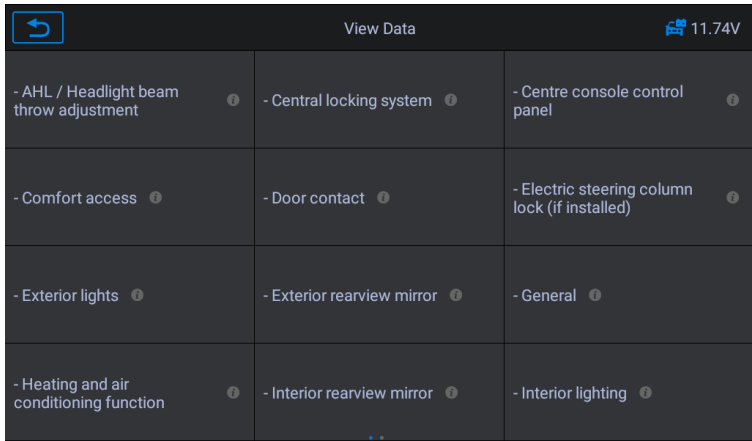

Figure 4-21 Sample View Data Screen 1

Select any module manually, and you will enter the specific data flow list. Gesture scrolling allows you to quickly move through the data list. Simply swipe the screen up or down to locate the data you want. The figure below shows a typical Live Data screen:

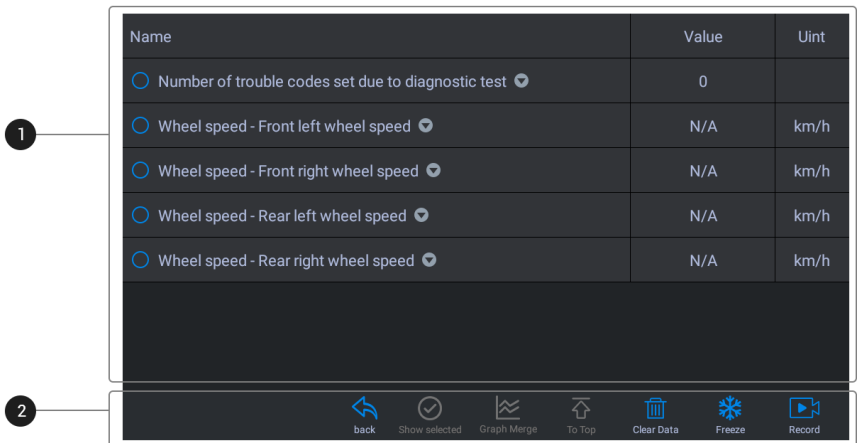

Figure 4-22 Sample View Data Screen 2

1. Main Section

- Name Column – displays the parameter names.
 - a) Check Box – tap the check box on the left side of the

parameter name to make item selection. Tap the check box again to de-select the item.

b) Drop-down Button – tap the drop-down button on the right side of the parameter name to open a sub menu that provides various choices for data display mode.

- Value Column – displays the values of the parameter items.
- Unit Column – displays the unit for the parameters.

To change the unit mode, return to the “Settings” button and select the desired mode.

Display Mode

There are four types of display modes available for data viewing, allowing you to view various types of parameters in the most suitable way.

Tapping the drop-down button on the right side of the parameter name to open a sub menu. There are four buttons to configure the data display mode, and a Help button for access to additional information.

Each parameter item displays the selected mode independently.

- 1) Analog Gauge Mode – displays the parameters in form of an analog meter graph.
- 2) Text Mode – this is the default mode that displays the parameters in texts and displays in list format.

NOTE

Reading of status parameters, such as a switch reading, which are mostly in word form, such as ON, OFF, ACTIVE, and ABORT, can only be displayed in Text Mode. Whereas reading of value parameters, such as a sensor reading, can be displayed in text mode and other graph modes.

- 3) Waveform Graph Mode – displays the parameters in waveform graphs.

When this mode is applied, you can use two fingers to zoom in or out.

- 4) **Digital Gauge Mode** – displays the parameters in form of a digital gauge graph.

2. Functional Buttons

The operations of available functional buttons on Live Data screen are described below:

- **Back** – returns to previous screen or exits the function.
- **Record** – starts recording the retrieved live data; the recorded data is then stored as a video clip in the Data Manager application for future reviews. This function could be triggered automatically at preset threshold value or manually as you choose. The triggering mode and record duration can be configured in the Setting mode of Live Data.
- **Freeze frame** – displays the retrieved data in freeze frame mode.
 - 1) **Previous Frame** – moves to the previous frame in the freeze frame data.
 - 2) **Next Frame** – moves to the next frame in the freeze frame data.
- **Clear Data** – clears all previously retrieved parameter values at a selected point.
- **To Top** – moves a selected data item to the top of the list.
- **Graph Merge** – tap this button to merge selected data graphs (for Waveform Graph Mode only). This function is useful when making a comparisons between parameters.

NOTE

This mode supports Graph Merge for 3 to 4 parameter items. Up to 4 parameter items combined.

To cancel Graph Merge mode, tap the ⊗ button in the upper

right corner.

- **Show** – tap this option to switch between the two options; one displays the selected parameter items, the other displays all the available items.

◆ Actuation Test

The "Actuation Test" function accesses vehicle specific subsystem tests and performs component tests. The available test functions vary according to the manufacturer, year and model, and the menu will only show the available test options.

When performing the actuation test, the tester inputs the command to the ECU to drive the actuator. This test can monitor the operation of the actuator by reading the ECU data of the engine. For example, by repeatedly switching the two working states of the solenoid valve, relay and switch, it can determine whether the system or components are working normally, and execute the command of the switch on the door or window.

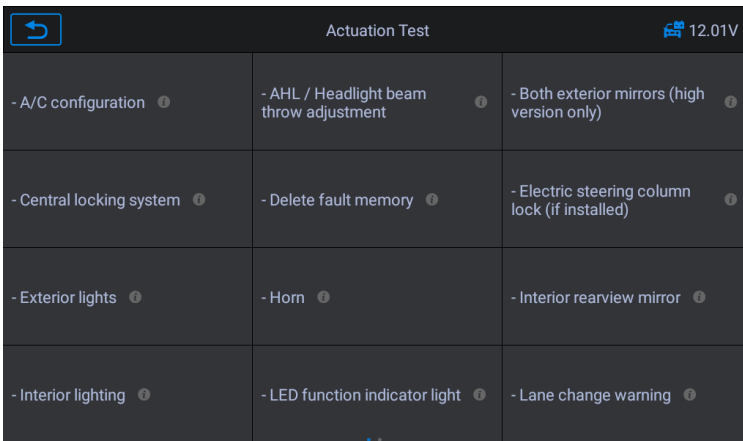

Figure 4-23 Sample Actuation Test Screen

➤ Left / Right turn signals

Through the left / right turn signal action test item, you can control the left and right turn signal flashing to test whether the turn signal works normally.

- Window regulator front / rear left / right: down / up

Through the window regulator action test item, you can control the whole vehicle window up and down to test whether the window up and down works normally.

- Windshield wiper motor (V) stage 1 / 2

Through the action test item of windshield wiper motor, the wiper can be controlled to work at 1 / 2 gear to test whether the wiper motor works normally

4.6 Generic OBD II Operations

A fast-access option for OBD II/EOBD vehicle diagnosis is available on the Vehicle Menu screen. This option presents a quick way to check for DTCs, isolate the cause of an illuminated malfunction indicator lamp (MIL), check monitor status prior to emissions certification testing, verify repairs, and perform a number of other services that are emissions-related. The OBD direct access option is also used for testing OBD II/EOBD compliant vehicles that are not included in the Diagnostics database.

Functions of the diagnostics toolbar buttons at the top of the screen are the same as those available for specific vehicle diagnostics. See *Table 4-1 Diagnostics Toolbar Buttons* on page 21 for details.

4.6.1 General Procedure

- **To access the OBD II/EOBD diagnostics functions**
 1. Tap the **Diagnostics** application button from the CR MAX Job Menu. The Vehicle Menu displays.
 2. Tap the **EOBD** button. The device will automatically establish communication with the vehicle, as shown in the figure below:

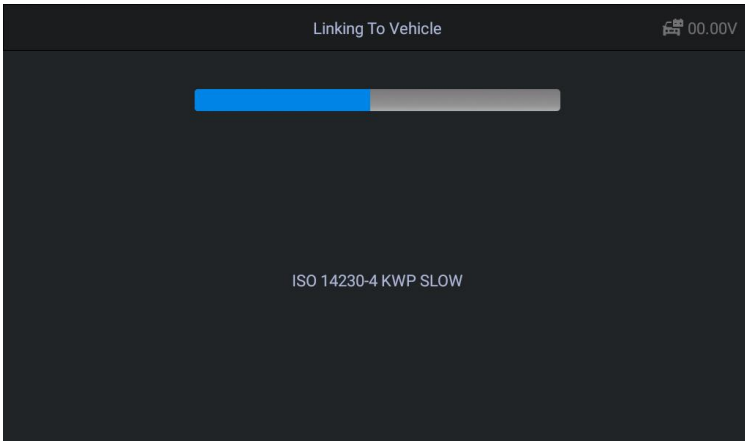

Figure 4-24 Sample OBDII Screen 1

3. When the communication is complete, vehicle protocol information will be displayed. Tap OK to proceed to the next step.

 A screenshot of a software interface titled "Monitor Overview". At the top left is a refresh icon, and at the top right is a battery icon and the text "12.00V". The main content is a table with the following data:

MIL Status	OFF
Codes Found	14
Monitor Completed	5
Monitor Not Completed	2
Monitor Not Supported	3
Ignition Type	Spark
Protocol Type	CAN

 At the bottom right of the screen are two buttons labeled "ESC" and "OK".

Figure 4-25 Sample OBDII Screen 2

4. Select a specific protocol under the **Protocol** option. Wait for the OBD II Diagnostic Menu to display.

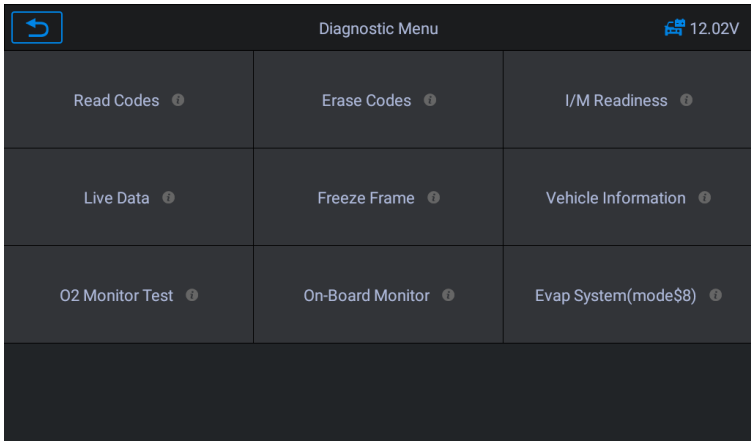

Figure 4-26 Sample OBD II Diagnostic Menu

NOTE

Tapping (i) button beside the function name to display additional function information.

Select a function option to continue.

- **Read Codes**
- **Erase Codes**
- **I/M Readiness**
- **Live Data**
- **Freeze Frame**
- **Vehicle Information**
- **Monitor Test**
- **On-Board Monitor**
- **Evap System(mode\$8)**

NOTE

Some functions are supported only on certain vehicle manufacturers.

4.6.2 Function Descriptions

This section describes the various functions of each diagnostic option:

Read Codes

When this function is selected, the screen displays a list of Stored Codes and Pending Codes. You can save the fault code information of the current page through the save button in the lower right corner.

read Codes		
C1EC5	Stored	The fault code is not found in the database, please refer to the vehicle's user manual.
U31FB	Stored	The fault code is not found in the database, please refer to the vehicle's user manual.
P380B	Stored	The fault code is not found in the database, please refer to the vehicle's user manual.
U3E56	Stored	The fault code is not found in the database, please refer to the vehicle's user manual.
U2A5A	Stored	The fault code is not found in the database, please refer to the vehicle's user manual.
U26D2	Stored	The fault code is not found in the database, please refer to the vehicle's user manual.

Figure 4-27 Sample Read Codes Screen

Stored codes are the current emission related DTCs from the ECM of the vehicle. OBD II/EOBD Codes have a priority according to their emission severity, with higher priority codes overwriting lower priority codes. The priority of the code determines the illumination of the MIL and the codes erase procedure. Manufacturers rank codes differently, so expect to see differences between makes.

Erase Codes

This option is used to clear all emission related diagnostic data such as, DTCs, freeze frame data and manufacturer specific enhanced data from the vehicle's ECM.

A confirmation screen displays when the clear codes option is selected to prevent accidental loss of data. Select Yes on the confirmation screen to continue or No to exit.

I/M Readiness

This function is used to check the readiness of the monitoring system. It is an excellent function to use prior to having a vehicle inspected for

compliance to a state emissions program. Selecting I/M Readiness opens a submenu with two choices:

- **Since Codes Cleared** – displays the status of monitors since the last time the codes are erased.
- **This Drive Cycle** – displays the status of monitors since the beginning of the current drive cycle.

Live Data

This function displays the real time PID data from ECU. Displayed data includes analog inputs and outputs, digital inputs and outputs, and system status information broadcast on the vehicle data stream.

Live data can be displayed in various modes, see Live Data on page 29 for detailed information.

Freeze Frame

In most cases the stored frame is the last DTC that occurred. Certain DTCs, which have a greater impact on vehicle emission, have a higher priority. In these cases, the top prioritized DTC is the one for which the freeze frame records are retained. Freeze frame data includes a “snapshot” of critical parameter values at the time the DTC is set.

Vehicle Information

The option displays the vehicle identification number (VIN), the calibration identification, and the calibration verification number (CVN), and other information of the test vehicle.

Monitor Test

This service enables bi-directional control of the ECM so that the diagnostic tool is able to transmit control commands to operate the vehicle systems. This function is useful in determining whether the ECM responds to a command well.

On-Board Monitor

This option allows you to view the results of On-Board Monitor tests. The tests are useful after servicing or after erasing a vehicle’s control module

memory.

Evap System

This item is used to issue the EVAP system test command.

4.7 Exiting Diagnostics

The Diagnostics application remains open as long as there is active communication with the vehicle. You must exit the diagnostics operation to stop all communications with the vehicle before closing the Diagnostics application.

NOTE

Damage to the vehicle electronic control module (ECM) may occur if communication is disrupted. Make sure all connections, such as USB cable and wireless connections, are properly connected at all times during testing. Exit all tests before disconnecting the test connection or powering down the tool.

➤ **To exit the Diagnostics application**

1. From an active diagnostic screen, tap the **Back** or **ESC** functional button to exit a diagnostic session step-by-step.
2. From the Vehicle Menu screen, tap the **Back** button on the top toolbar; or tap the **Back** button on the navigation bar at the bottom of the screen.
3. Or tap the **Home** button on the diagnostics toolbar to exit the application directly and return to the CR MAX Job Menu.

Once the Diagnostics application is no longer communicating with the vehicle, it is safe to open other CR MAX applications, or exit the CR MAX Diagnostic System and return to the Android System's Home screen.

5 Service Operations

The Service section is specially designed to provide you with quick access to the vehicle systems for various scheduled service and maintenance performances. The typical service operation screen is a series of menu driven executive commands. By following the on-screen instructions to select appropriate execution options, enter correct values or data, and perform necessary actions, the system will guide you through the complete performance for various service operations.

The most commonly performed service functions include:

1. **ABS Bleeding Service**
2. **Oil Reset Service**
3. **EPB Service**
4. **Electronic Throttle Control Service**
5. **Injector Service**
6. **SAS Service**
7. **BMS Service**
8. **DPF Service**
9. **Head Lamp reset**
10. **Air Suspension**
11. **TPMS programming service**
12. **Gearbox Reset**
13. **Air conditioning service**
14. **Air Filter**
15. **Fuel Pump activation function**
16. **Engine Idle**
17. **Body stability**
18. **Door**
19. **Seat**

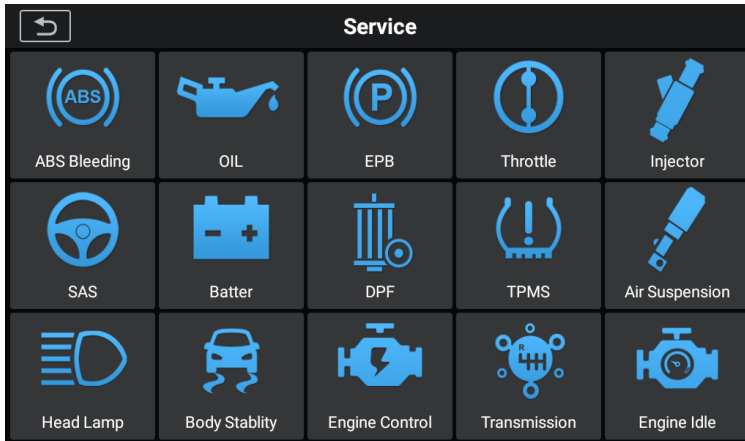

Figure 5-1 Sample Service Function List

After entering each special function, the screen will display the Vehicle Manufacturer, you need to make a step-by-step selection according to your test vehicle.

5.1 ABS Bleeding

When the ABS contains air, or the ABS computer / ABS pump / brake master cylinder / brake cylinder/ brake fluid is replaced, the ABS bleeding function must be performed to bleed the brake system to restore ABS brake sensitivity.

NOTE

This operation requires assistance.

Using **BMW** as an example:

➤ To perform ABS Bleeding functions

1. Tap the **Service** application button from the CR MAX Job Menu.
2. Tap **ABS Bleeding** button and wait for the vehicle manufacturer screen. Then tap BMW icon from the screen. Waiting for vehicle communication.

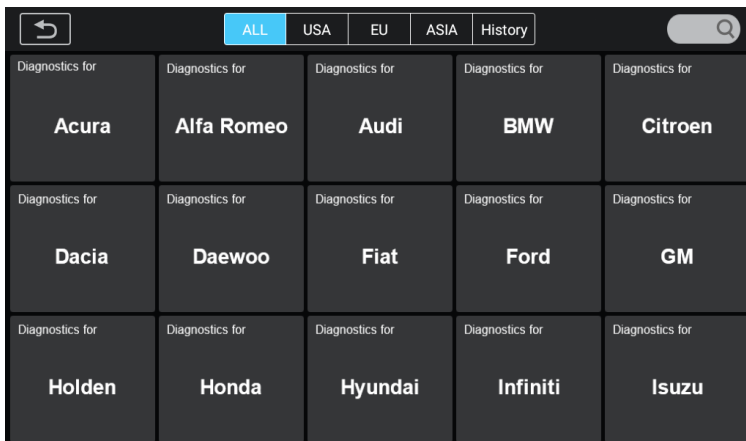

Figure 5-2 Sample ABS Bleeding Function Screen 1

3. You can tap **Auto Identify** to acquire vehicle VIN information and tap **OK** to confirm. Or you can tap the **Vehicle Select** to choose the **correct vehicle according to the on-screen instructions**. See *Vehicle Identification* on page 14 for detail.
4. Tap the function you want in the ABS Bleeding function list, the list may vary for different vehicles being tested.

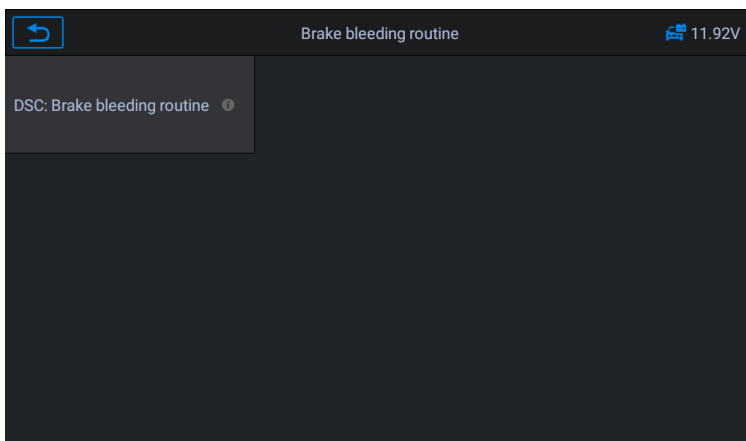

Figure 5-3 Sample ABS Bleeding Function Screen 2

5. Read the information on the screen carefully and prepare according to the requirements of the screen. After working on the

brake system, the brake bleeding routine must be carried out

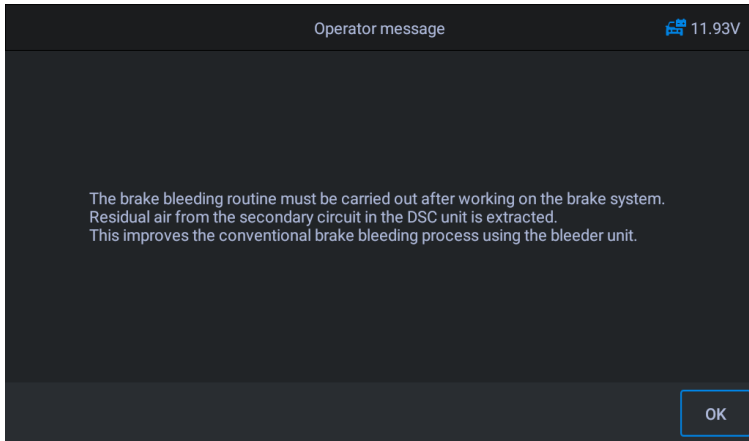

Figure 5-4 Sample ABS Bleeding Function Screen 3

6. Make corresponding preparations, connect the bleeder unit and turn on the switch. Flush brake system with bleeder at all four wheel until brake fluid free of foam and bubbles emerges.

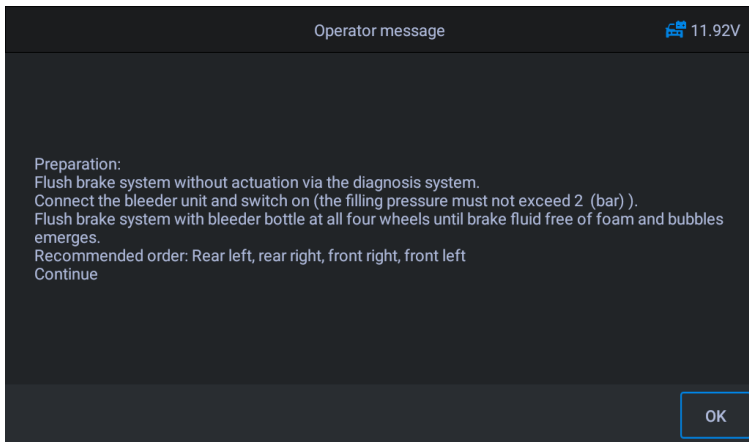

Figure 5-5 Sample ABS Bleeding Function Screen 4

7. The screen prompts has the brake system has been flushed?, If so, tap Yes to continue.

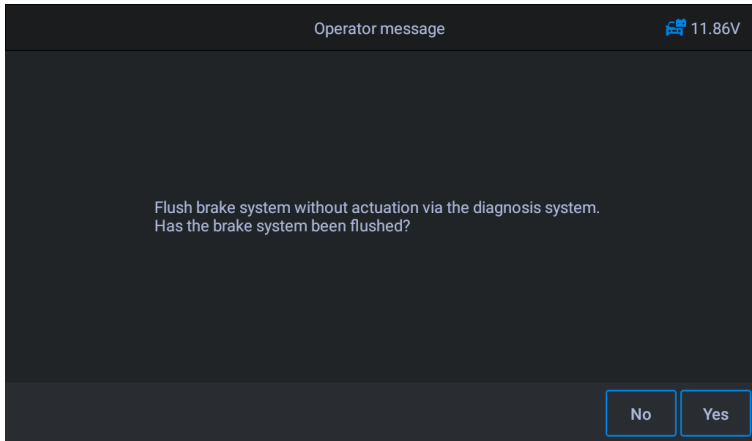

Figure 5-6 Sample ABS Bleeding Function Screen 5

8. In the following procedure, perform the exhaust procedure separately. Follow the on-screen prompts. Until the service function finished.

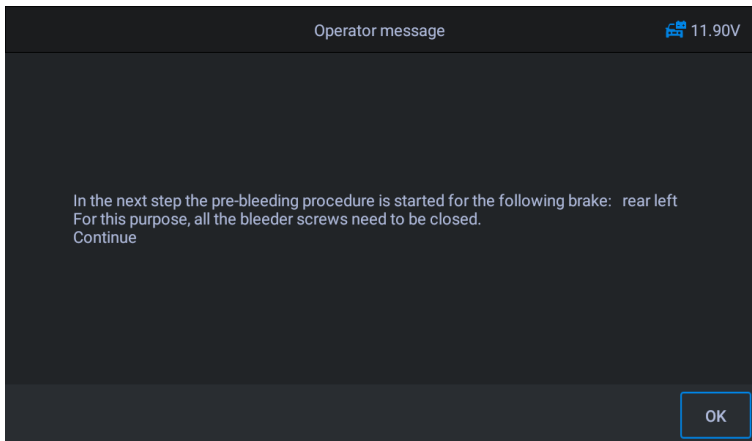

Figure 5-7 Sample ABS Bleeding Function Screen 6

5.2 Oil Reset Service

This function allows you to perform reset for the Engine Oil Life system, which calculates an optimal oil life change interval depending on the vehicle driving conditions and climate. The Oil Life Reminder must be reset

every time the oil is changed, so the system can calculate when the next oil change is required. **Different vehicles may have different methods to do the oil maintenance, generally, oil change is required whenever oil lamp is on and the recommended maintenance period is reached. The Oil Reset function can reset the maintenance period and distance and turn off the lamp when you really change the oil.**

 **NOTE**

All required work must be carried out before the service indicators are reset. Failure to do so may result in incorrect service values and cause DTCs to be stored by the relevant control module.

All software screens shown in this manual are examples, actual test screens may vary for each vehicle being tested. Observe the menu titles and on-screen instructions to make correct option selections.

Using **Benz** as an example.

- **Set the distance driven since last oil change :**
- 1. Tap the **Service** application button from the CR MAX Job Menu.
- 2. Tap **Oil** icon and wait for the vehicle manufacturer screen. Then tap **Benz** icon from the screen. Waiting for vehicle communication.
- 3. Then you can tap **Auto Identify** to acquire vehicle VIN information and tap **OK** to confirm. Or you can tap the **Vehicle Select** to choose the **correct vehicle according to the on-screen instructions**. See *Vehicle Identification* on page 14 for detail.
- 4. **Select the "Distance driven since last oil change" option in the function list. Turn on the vehicle ignition.**

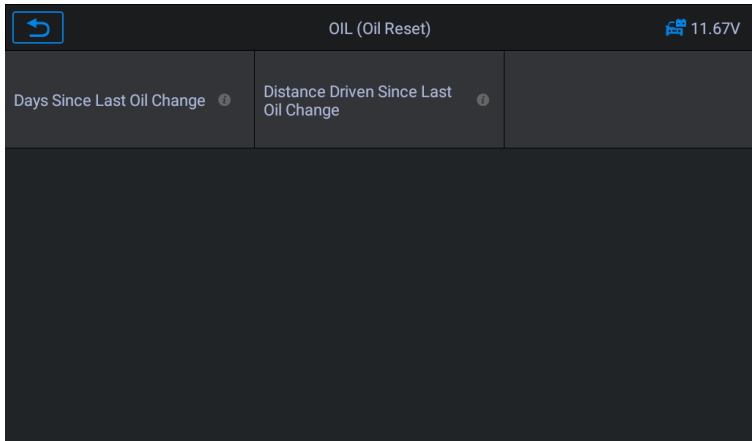

Figure 5-8 Sample OIL Function Screen 1

5. Wait for communication between vehicle and equipment. When the data stream interface appears, tap [Reset] to next step.

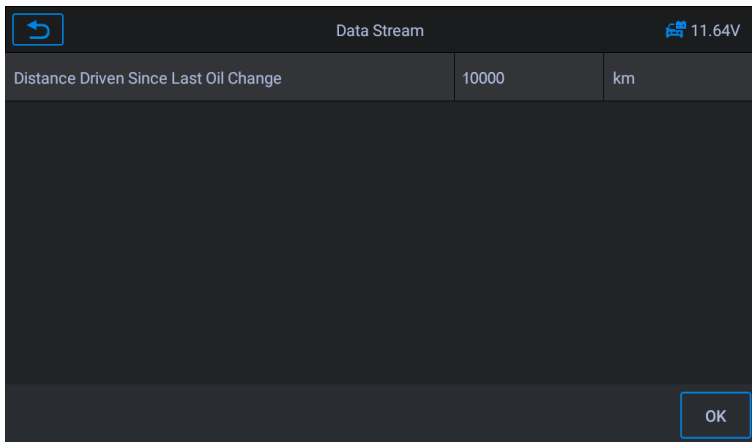

Figure 5-9 Sample OIL Function Screen 2

6. Enter the required mileage after oil change and tap [OK] to next step until the application is completed. Tap [OK] to exit.

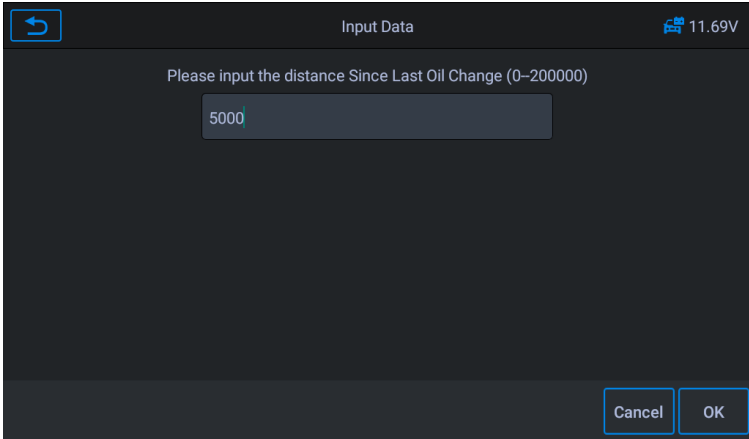

Figure 5-10 Sample OIL Function Screen 3

- Set the number of days since last oil change:
1. Tap the **Service** application button from the CR MAX Job Menu.
 2. Tap **Oil Reset** button and wait for the vehicle manufacturer screen. Then you can tap **Auto Identify** to acquire vehicle VIN information and tap **OK** to confirm. Or you can tap the **Vehicle Select** to choose the test vehicle. See *Vehicle Identification* on page 14 for detail
 3. Select the "Days since last oil change" option in the function list. Turn on the vehicle ignition.

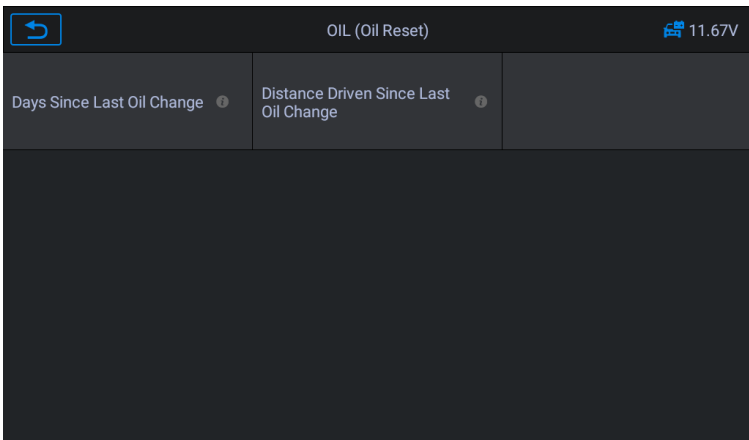

Figure 5-11 Sample OIL Function Screen 4

4. Wait for communication between vehicle and equipment. When the interface of data stream appears, tap [Reset] to next step.

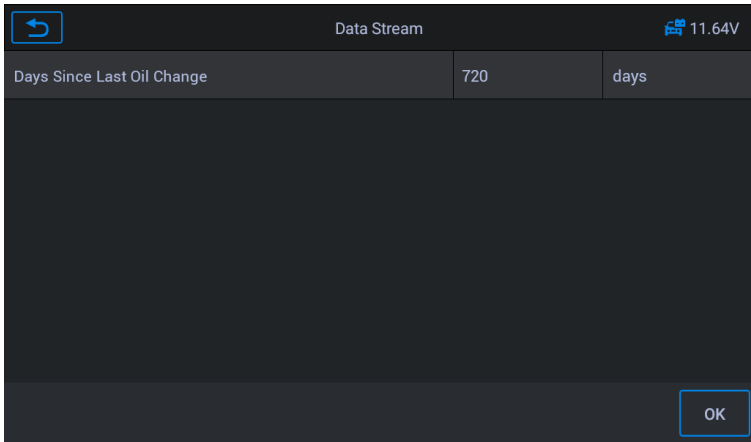

Figure 5-12 Sample OIL Function Screen 5

5. Enter the number of days after oil change and tap [OK] to next step until the application is completed. Tap [OK] to exit.

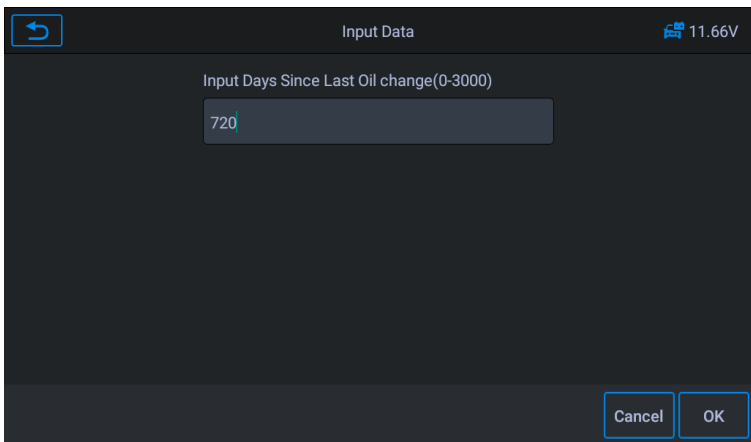

Figure 5-13 Sample OIL Function Screen 6

5.3 Electronic Parking Brake (EPB) Service

This function has a multitude of usages to maintain the electronic braking system safely and effectively. The applications include deactivating and

activating the brake control system, assisting with brake fluid control, opening and closing brake pads, and setting brakes after disc or pad replacement.

Electronic Parking Brake (EPB) system maintenance, deactivates and reactivates the EPB system for replacement and initialization.

Using Jaguar as an example:

➤ **To perform EPB functions**

1. Tap the **Service** application button from the CR MAX Job Menu.
2. Tap **EPB** button and wait for the vehicle manufacturer screen. Then tap **Jaguar** icon from the screen. Waiting for vehicle communication.
3. You can tap **Auto Identify** to acquire vehicle VIN information and tap **OK** to confirm. Or you can tap the **Vehicle Select** to choose the **correct vehicle according to the on-screen instructions**. See *Vehicle Identification* on page 14 for detail
4. Select "electronic parking brake - electronic parking brake clutch calibration" in the function list.

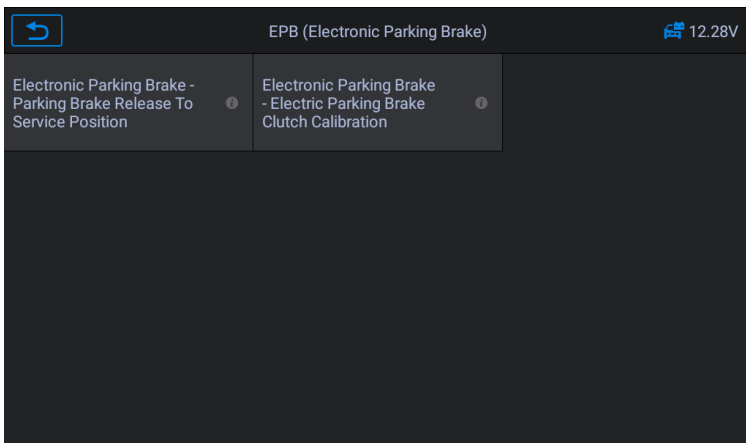

Figure 5-14 Sample EPB Function Screen 1

5. Operate step by step according to the screen, and make the vehicle on the free ramp as required, and wait for the screen

communication to succeed.

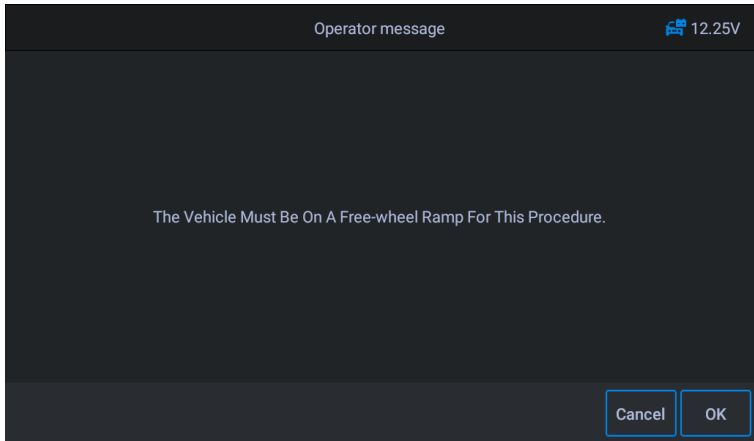

Figure 5-15 Sample EPB Function Screen 2

6. As shown in the figure below, make sure that the parking brake is switched on and the shift lever is in N gear. Operate the clutch as required when the engine is running.

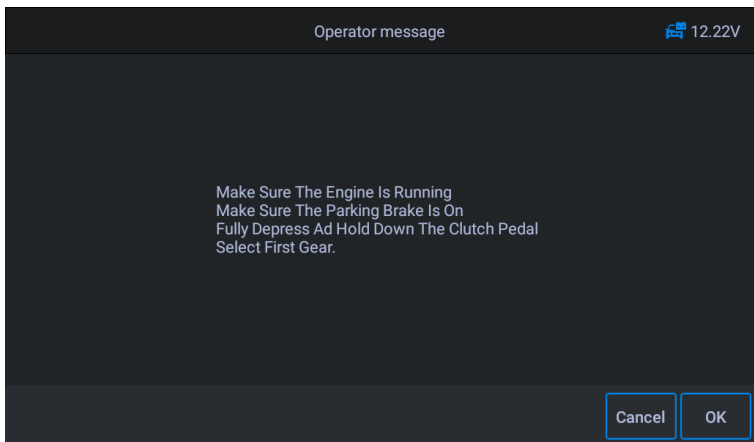

Figure 5-16 Sample EPB Function Screen 3

7. Press the [OK] to next step until the calibration is successful, fully depress the clutch pedal, select neutral and release the clutch pedal.

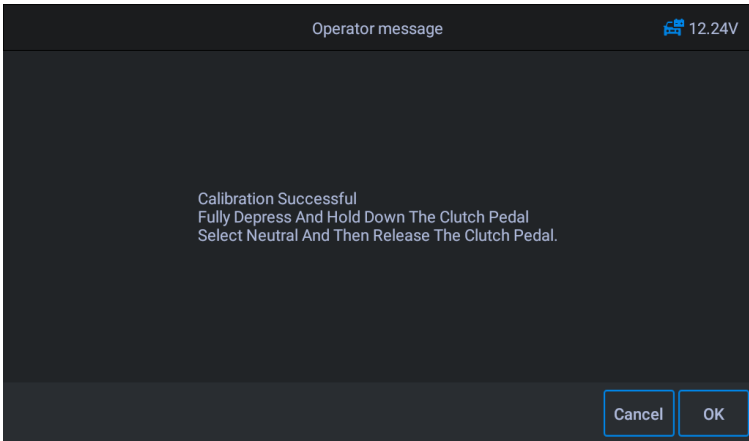

Figure 5-17 Sample EPB Function Screen 4

8. The screen prompts that the application is complete, and press [OK] to exit.

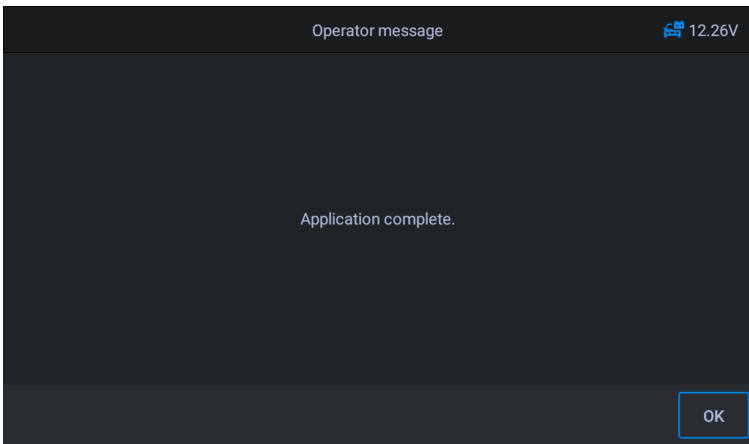

Figure 5-18 Sample EPB Function Screen 5

5.4 Electronic Throttle Control

Electronic Throttle Control system (ETC), relearns the throttle value control value while clear or replace the throttle value.

Using **Benz** as an example

➤ **To perform Throttle functions**

1. Tap the **Service** application button from the CR MAX Job Menu.
2. Tap **Throttle** icon and wait for the vehicle manufacturer screen. Then tap **Benz** icon from the screen. Waiting for vehicle communication.
3. You can tap **Auto Identify** to acquire vehicle VIN information and tap **OK** to confirm. Or you can tap the **Vehicle Select** to choose the **correct vehicle according to the on-screen instructions**. See *Vehicle Identification* on page 14 for detail.
4. Tap the needed service in the **Throttle** function list. The list may vary by vehicle. **Learn the throttle valve stop point value. Select the "teach in of throttle valve stop" option in the function list. Turn on the vehicle ignition.**

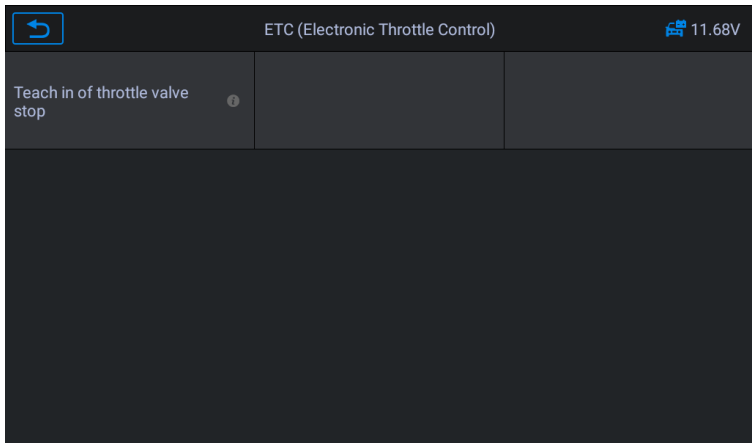

Figure 5-19 Sample ETC Function Screen 1

5. **Read the operator message on the screen, tap OK to proceed to the next step, and set the learning parameters as required.**

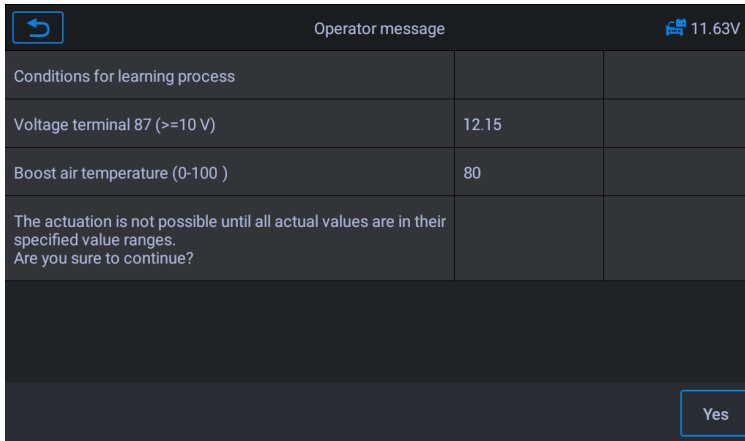

Figure 5-20 Sample ETC Function Screen 2

6. Press the [Yes] button to perform the learning process. Until the application is complete, press [OK] to exit.

5.5 Injector

When individual injectors are renewed, the injector control module requires the new configuration values for the injector to perform correctly. Write injector actual code or rewrite code in the ECU to the injector code of the corresponding cylinder so as to more accurately control or correct cylinder injection quantity. After the ECU or injector is replaced, injector code of each cylinder must be confirmed or re-coded so that the cylinder can better identify injectors to accurately control fuel injection.

Using **Land Rover** as an example:

If the vehicle has replaced the fuel injector, in order to ensure the normal operation of the fuel injector, you need to carry out this operation to replace the fuel injector code.

➤ To perform Injector functions

1. Tap the **Service** application button from the CR MAX Job Menu.
2. Tap **Injector** icon and wait for the vehicle manufacturer screen.

Then tap **Land Rover** icon from the screen. Waiting for vehicle communication.

3. You can tap **Auto Identify** to acquire vehicle VIN information and tap **OK** to confirm. Or you can tap the **Vehicle Select** to choose the **correct vehicle according to the on-screen instructions**. See *Vehicle Identification* on page 14 for detail.
4. Select the "Powertrain Set - Up - Injector Replacement" option in the function list. The list may vary by vehicle.

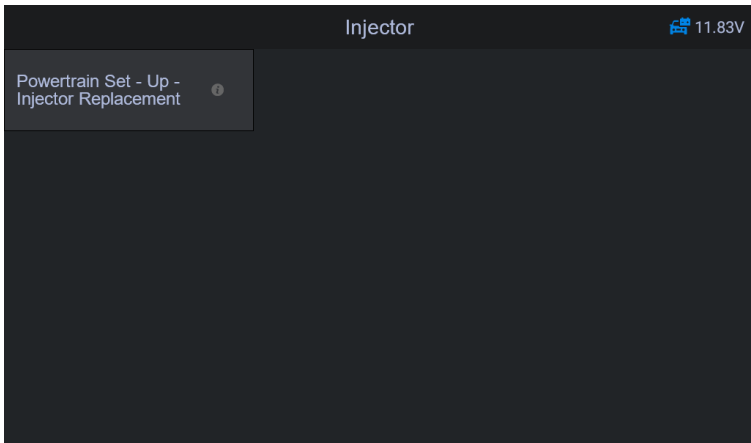

Figure 5-21 Sample Injector Screen 1

5. When the next screen prompts to replace a single injector, the injector control module needs a new configuration value to make the injector work normally.

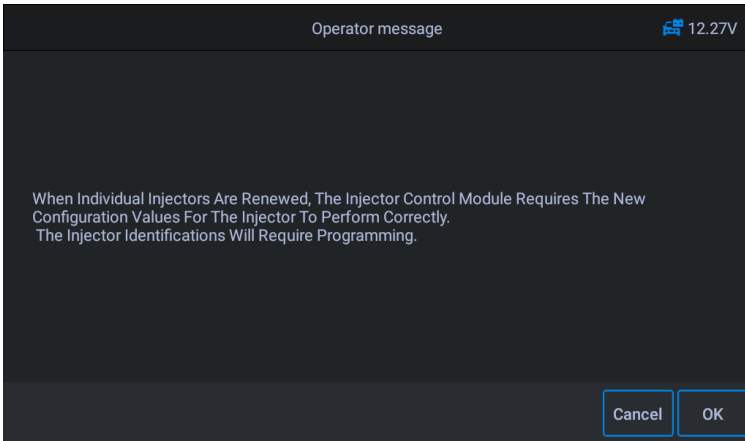

Figure 5-22 Sample Injector Function Screen 2

6. Read the screen prompts carefully, you will know the information about the fuel injector code. Follow the screen operation step by step, tap [OK] to perform the next step.

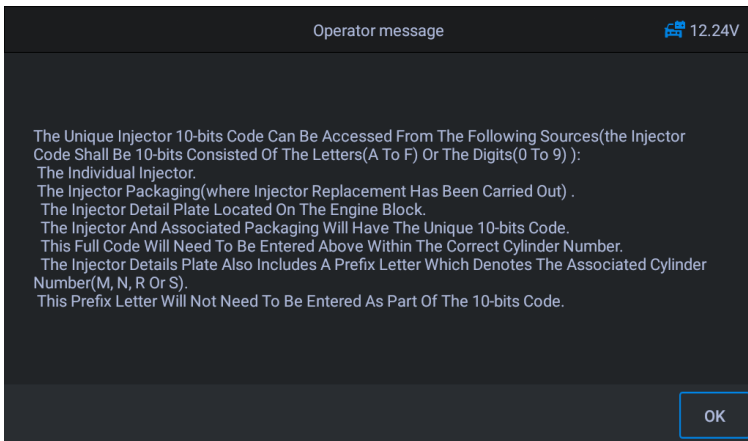

Figure 5-23 Sample Injector Screen 3

NOTE

During The Procedure, The Engine Shall Be Off. And The Supply Voltage Shall Be 12.5V (standard). If The Voltage Is Less Than The Standard, Then The Procedure May Fail.

7. As shown in the figure below, select the serial number of the fuel

injector to be replaced. For example, select the injector 1 number.

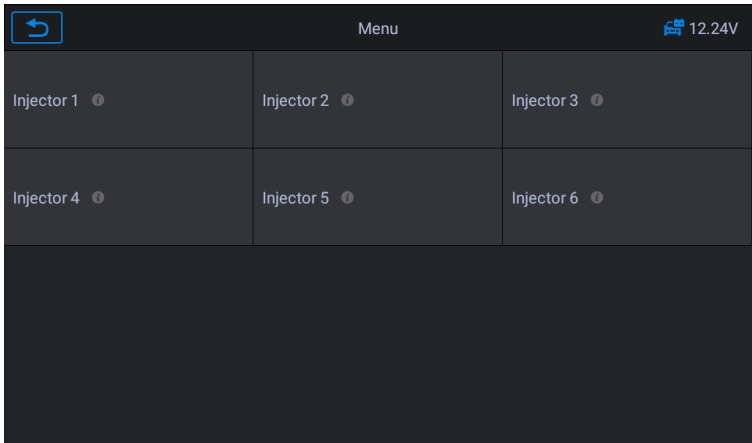

Figure 5-24 Sample Injector Screen 4

8. Read the 10 digit sensor code from the replaced injector, press the [OK] to call up the input box and input the identification number.

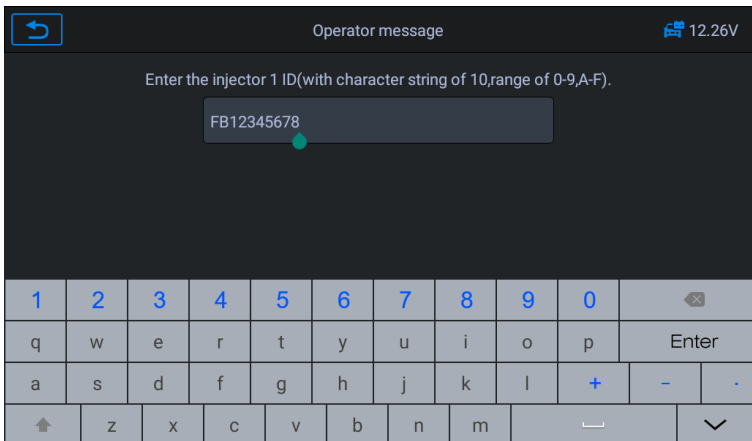

Figure 5-25 Sample Injector Function Screen 5

9. Press [OK] to complete the execution. You can perform the next injector code change or exit application.

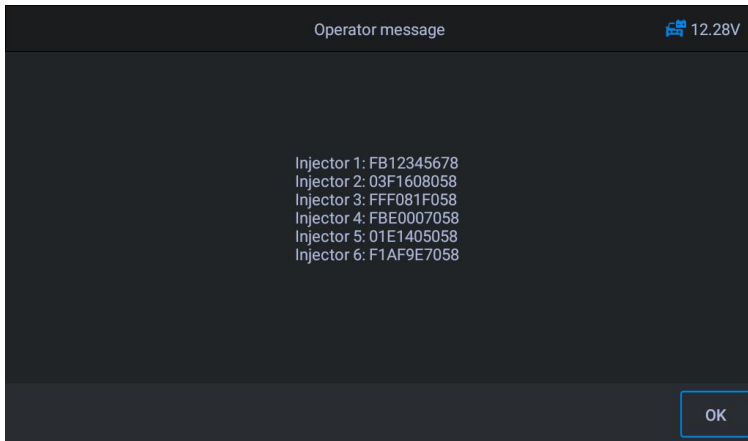

Figure 5-26 Sample Injector Function Screen 6

5.6 Steering Angle Sensor (SAS) Service

SAS: Steering Angle Sensor (SAS) calibration, calibrates the steering wheel to straight ahead, or recalibrates SAS while steering part replacement.

Calibration must be completed after the following operations:

- Steering wheel replacement
- Steering angle sensor replacement
- Any maintenance involving opening the connector hub from the steering angle sensor to the column
- Any maintenance or repair work on the steering linkage, steering gear or other related mechanism
- Wheel alignment or wheel track adjustment
- Accident repairs where damage to the steering angle sensor or assembly, or any part of the steering system may have occurred.

NOTE

- 1) ICARSOFT accepts no responsibility for any accident or injury arising

from servicing the SAS system. When interpreting DTCs retrieved from the vehicle, always follow the manufacturer's recommendation for repair.

- 2) All software screens shown in this manual are examples, actual test screens may vary for each vehicle being tested. Observe the menu titles and on-screen instructions to make correct option selections.
 - 3) Before starting the procedure, make sure the vehicle has an ESC button. Look for the button on dash.
-

Using **Jaguar** as an example.

Steering Column Calibration

If the steering column or instrument cluster is replaced or the instrument cluster software is updated, a body system steering column calibration is required.

1. Tap the **Service** application button from the CR MAX Job Menu.
2. Tap **SAS** button and wait for the vehicle manufacturer screen. Then tap **Jaguar** icon from the screen. Waiting for vehicle communication.
3. You can tap **Auto Identify** to acquire vehicle VIN information and tap **OK** to confirm. Or you can tap the **Vehicle Select** to choose the correct vehicle according to the on-screen instructions. See *Vehicle Identification* on page 14 for detail.
4. Select "body system steering column calibration" in the function list and follow the screen prompts. The list may vary by vehicle.

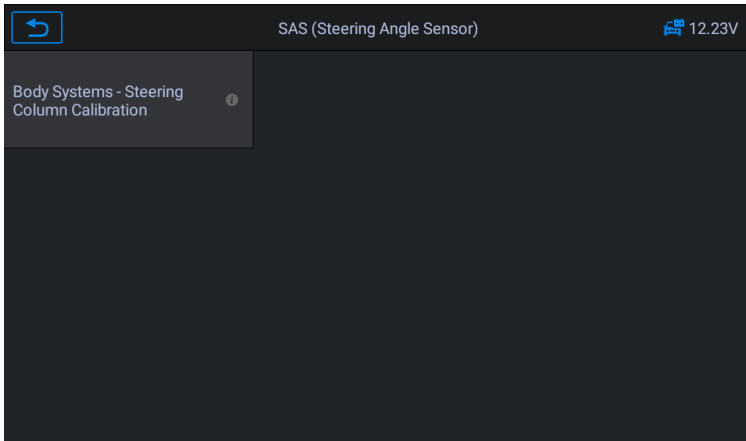

Figure 5-27 Sample SAS Function Screen 1

5. This routine is required if the steering column or the instrument cluster is replaced or the instrument cluster software is updated.

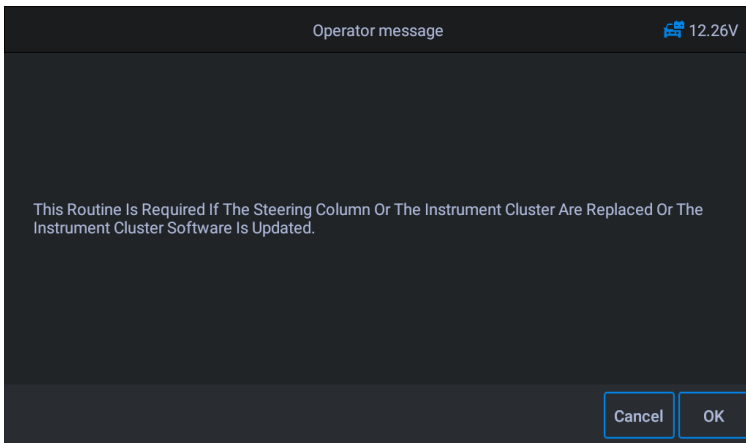

Figure 5-28 Sample SAS Function Screen 2

6. Read the 3 to 10 digits on the steering column label as required and enter the input on the next screen.

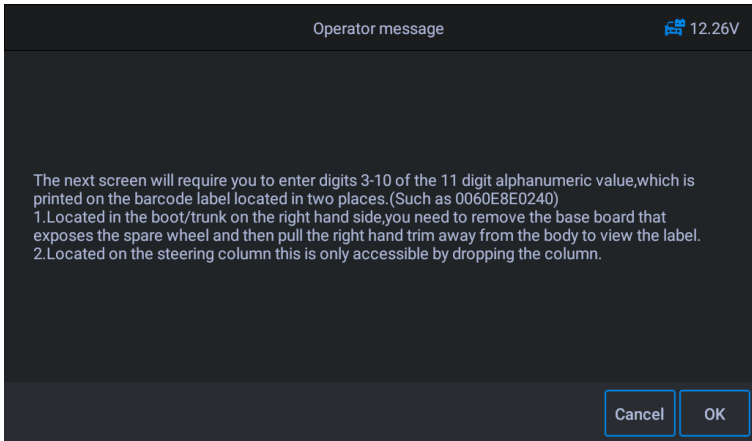

Figure 5-29 Sample SAS Function Screen 3

7. Tap the screen to call up the keyboard, enter 3 to 10 digits on the steering column label, and then tap OK to next.

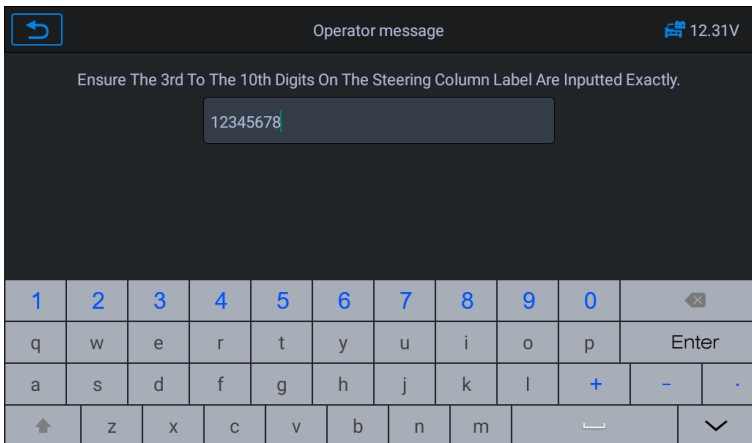

Figure 5-30 Sample SAS Function Screen 4

8. The system will enter communication, until the application program is completed. Tap OK to exit.

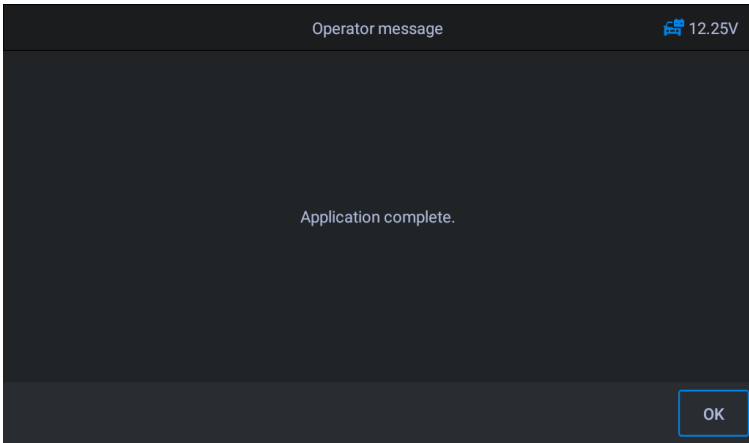

Figure 5-31 Sample SAS Function Screen 5

5.7 Battery Management System (BMS)

The BMS (Battery Management System) allows the scan tool to evaluate the battery charge state, monitor the close-circuit current, register the battery replacement, and activate the rest state of the vehicle.

NOTE

1. This function is not supported by all vehicles. The screens shown in this section are examples.
 2. The sub functions and actual test screens of the BMS may vary by vehicle. Please follow the on-screen instructions to make the correct selection.
-

The vehicle may use either a sealed lead-acid battery or an AGM (Absorbed Glass Mat) battery. Lead acid battery contains liquid sulphuric acid and can spill when overturned. AGM battery (known as VRLA battery, valve regulated lead acid) also contains sulphuric acid, but the acid is contained in glass mats between terminal plates.

It is recommended that the replacement aftermarket battery have the same specifications, such as capacity and type, as the battery in the vehicle. If

the original battery is replaced with a different type of battery (e.g. a lead-acid battery is replaced with an AGM battery) or a battery with a different capacity (mAh), the vehicle may require reprogramming the new battery type in

addition to performing the battery reset. Consult the vehicle manual for additional vehicle-specific information.

Register Battery Replacement

This option allows displaying the mileage reading of last battery replacement, registering the battery replacement after replacing a new battery and informing the power management system that a new battery has been fitted to the vehicle.

If the battery change is not registered, the power management system will not function properly, which may not provide the battery with enough charging power to operate the car and limit the functions of individual electrical equipment.

Using **BMW** as an example.

➤ To display the battery history

1. Tap the **Service** application button from the CR MAX Job Menu.
2. Tap **BMS** button and wait for the vehicle manufacturer screen. Then tap **BMW** icon from the screen. Waiting for vehicle communication.
3. You can tap **Auto Identify** to acquire vehicle VIN information and tap **OK** to confirm. Or you can tap the **Vehicle Select** to choose the **correct vehicle according to the on-screen instructions**. See *Vehicle Identification* on page 14 for detail.
4. Tap **Register Battery Replacement** in the EPB function list. The list may vary by vehicle.

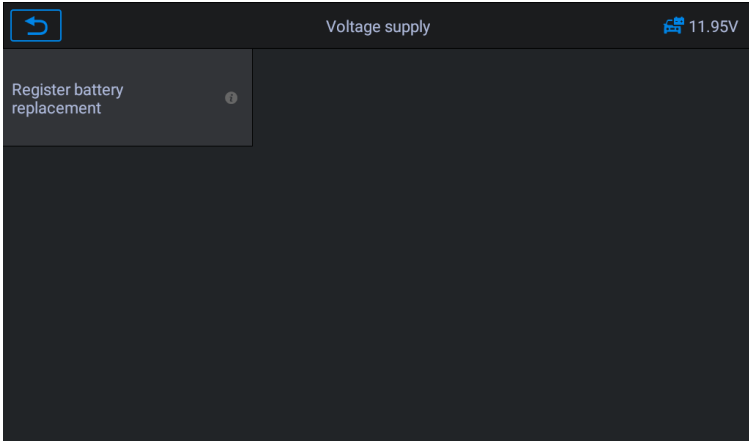

Figure 5-32 Sample BMS Function List

5. Tap on the service to perform. In this case, it is function 1. **Display distance reading at last battery exchange and one before last.** A notice screen displays.

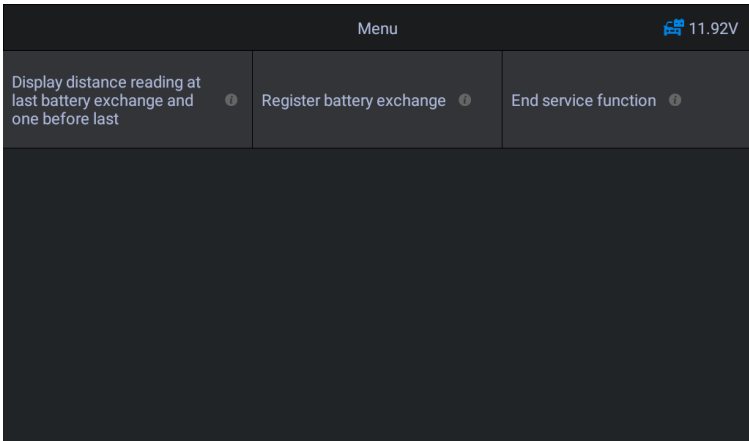

Figure 5-33 Sample BMS Screen 1

6. Read carefully the complete information and tap **OK**.

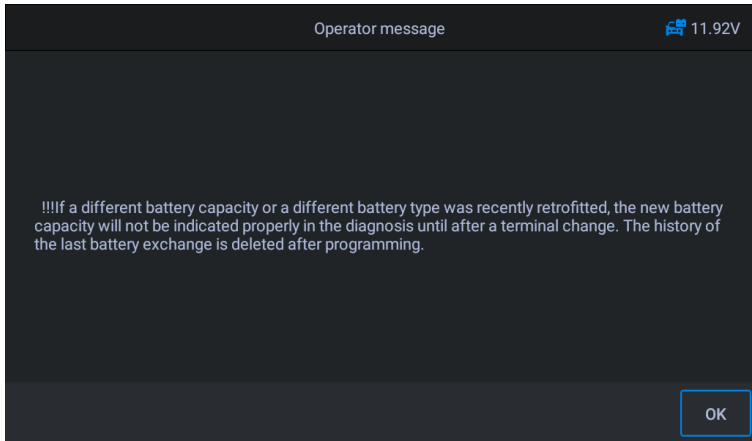

Figure 5-34 Sample BMS Screen 2

7. Check the battery capacity and the battery replacement information displayed. Then tap OK.

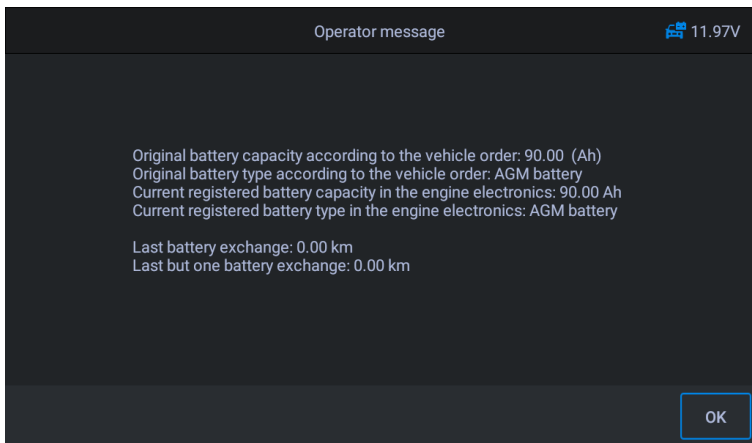

Figure 5-35 Sample BMS Screen 3

➤ **To register the battery replacement**

1. Tap on the corresponding service you want to carry out. In this case, it is function 2 **Register battery exchange**.

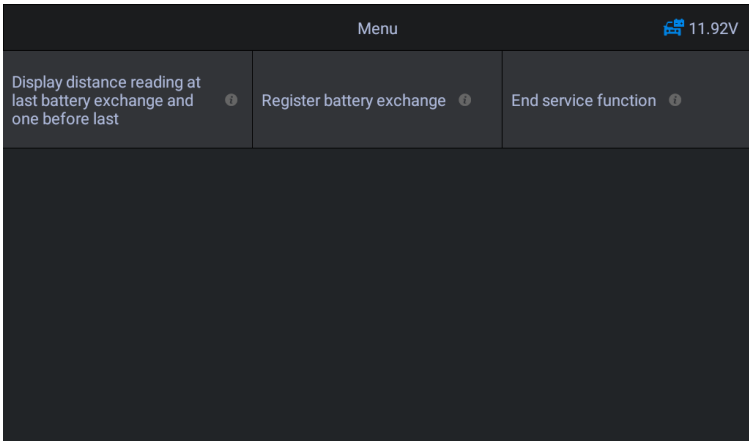

Figure 5-36 Sample BMS Screen 4

2. Read carefully the information on the screen and tap OK to view all the functions listed.

Four functions are listed:

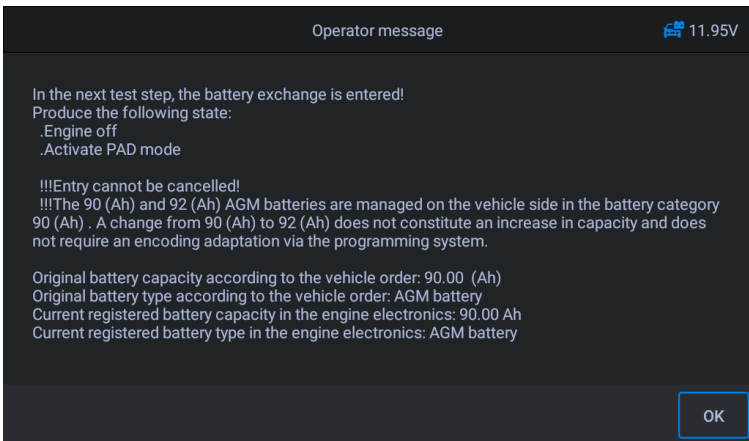

Figure 5-37 Sample BMS Screen 5

- 1) Enter battery exchange: Same capacity
- 2) Enter battery exchange: Higher/lower capacity
- 3) Enter battery exchange: Chang from normal lead-acid battery (white housing) to AGM battery (black housing)

4) End service function.

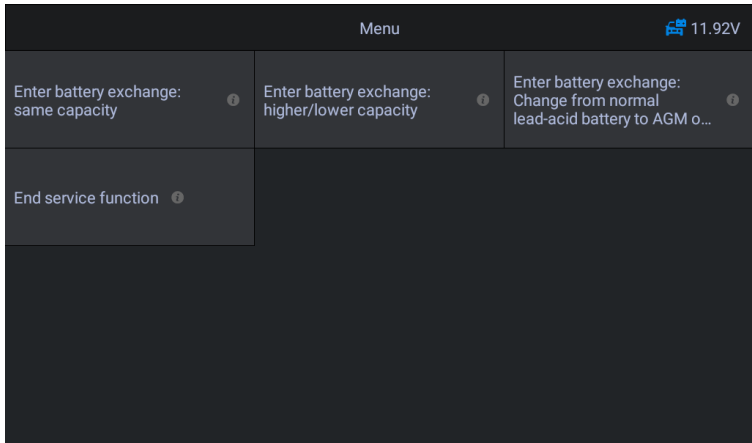

Figure 5-38 Sample BMS Function Screen

Using function 1 as an example.

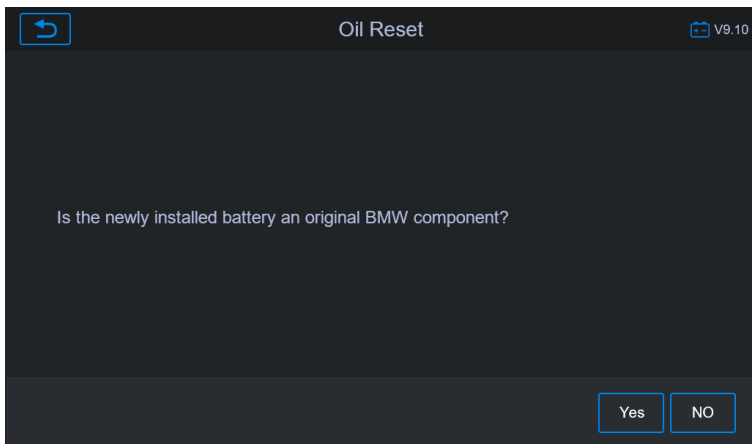

Figure 5-39 Sample BMS Screen 6

- 1) Read carefully the information on the screen and Waiting for battery component replacement.

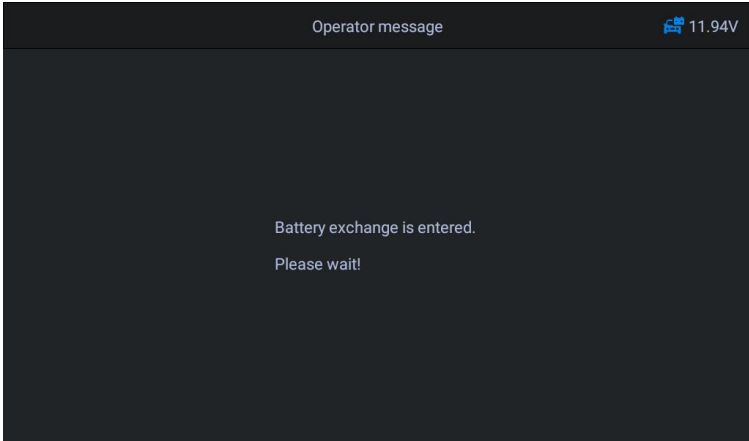

Figure 5-40 Sample BMS Screen 7

- 2) Once the code was accepted and the exchange is complete.

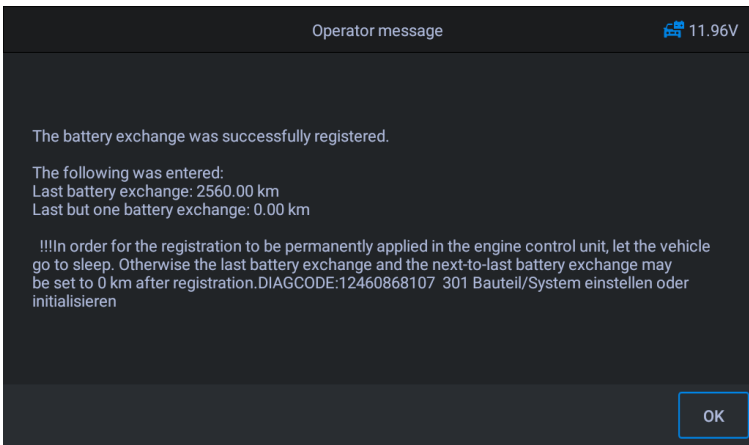

Figure 5-41 Sample BMS Screen 8

5.8 DPF Service

The DPF function allows you to carry out numerous functions to the Diesel Particulate Filter system. The tool will manage DPF regeneration, DPF component replacement teach-in and DPF teach-in after replacing the engine control unit.

The ECM monitors driving style and selects a suitable time to employ regeneration. Cars driven primarily at idling speed and low load will attempt to regenerate earlier than cars driven with higher loads and at higher speed. For regeneration to occur, a prolonged high exhaust temperature must be obtained.

In the event that the vehicle has been driven in such a way that regeneration is not possible, a diagnostic trouble code will be registered, DPF light and “Check Engine” indicator will display. A service regeneration can be performed using this tool.

Before carrying out a forced DPF regeneration, check the following items:

- The fuel light is not on.
- No DPF-relevant faults are stored in system.
- The vehicle has the correct spec engine oil.
- The oil for diesel is not contaminated.

❗ IMPORTANT

Before diagnosing a vehicle and attempting to perform an emergency regeneration, it is important to obtain a full diagnostic log and read out relevant measured value blocks.

📌 NOTE

- 1) The DPF will not regenerate if the engine management light is on, or there is a faulty EGR valve.
- 2) The ECU must be re-adapted when replacing the DPF and adding the fuel additive eolys.
- 3) If the vehicle needs to be driven in order to perform a DPF service, ALWAYS have a second person help you. One person should drive the vehicle while the other person observes the screen on the Tool. Trying to drive and observe the Scan Tool at the same time is dangerous, and could cause a serious traffic accident.

Using **Land Rover** as an example:

1. Tap the **Service** application button from the CR MAX Job Menu.
2. Tap **DPF** icon and wait for the vehicle manufacturer screen. Then tap **Land Rover** icon from the screen. Waiting for vehicle communication.
3. You can tap **Auto Identify** to acquire vehicle VIN information and tap **OK** to confirm. Or you can tap the **Vehicle Select** to choose the **correct vehicle according to the on-screen instructions**. See *Vehicle Identification* on page 14 for detail.
4. Select the "Powertrain - Diesel Particulate Fitter Dynamic Regeneration" option in the function list.

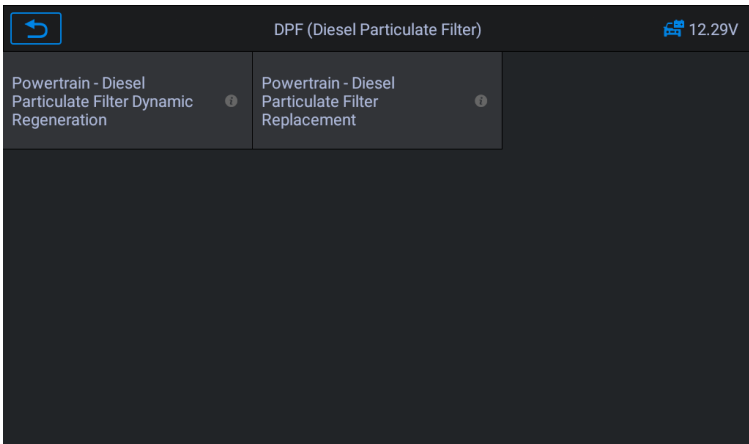

Figure 5-42 Sample DPF Service Function Menu 1

5. Carefully read the on-screen prompts on the conditions for dynamic regeneration of the diesel particulate filter, and pay special attention to the need for two people to perform this operation.

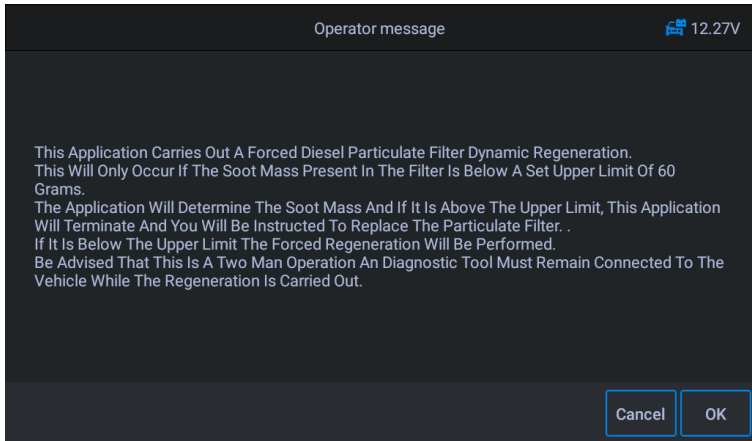

Figure 5-43 Sample DPF Service Function Screen 2

6. Follow the instructions on the screen step by step, and start the vehicle to drive at a speed higher than 40 km for about 15 minutes. Drive the vehicle to the required speed and press the "OK" button when the speed is reached.

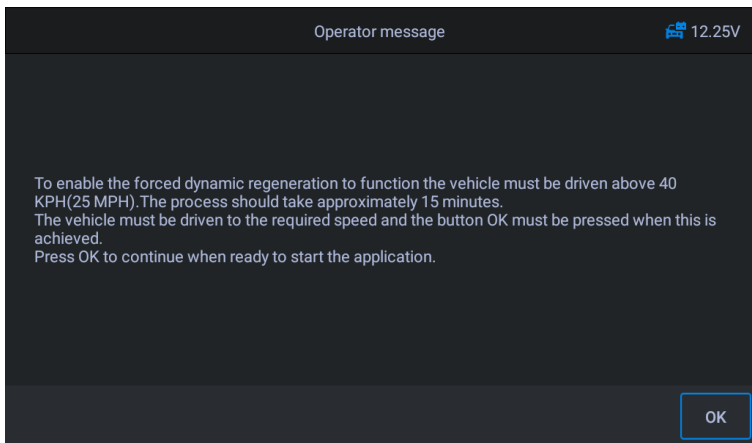

Figure 5-44 Sample DPF Service Function Screen 3

7. The program reads the temperature of the engine, and when the engine temperature reaches 60 °C, press the OK button.

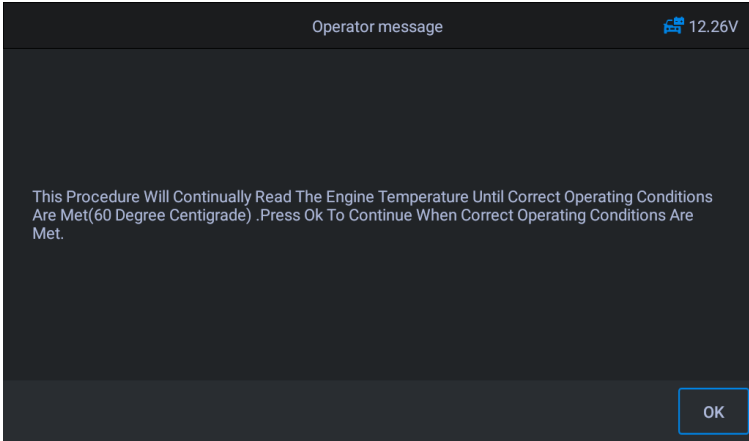

Figure 5-45 Sample DPF Service Function Screen 4

8. Subsequent procedures will force the engine management system to perform a diesel particulate filter regeneration.

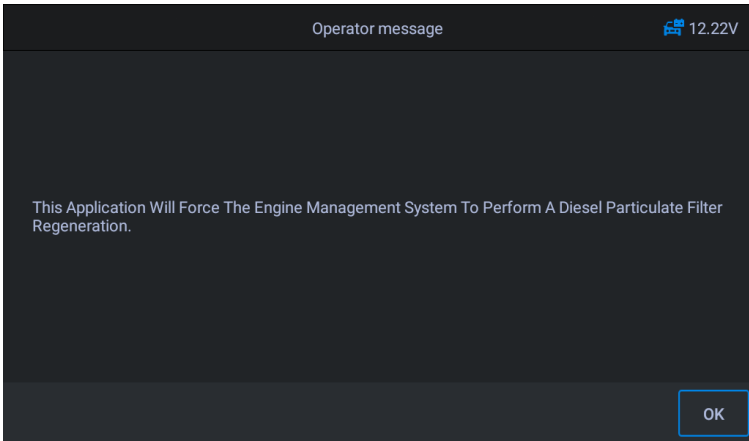

Figure 5-46 Sample DPF Service Function Screen 5

9. Regeneration is completed when it is indicated that the soot mass in the particulate filter is now at an acceptable lower limit. At this time, you can stop and turn off the ignition switch.

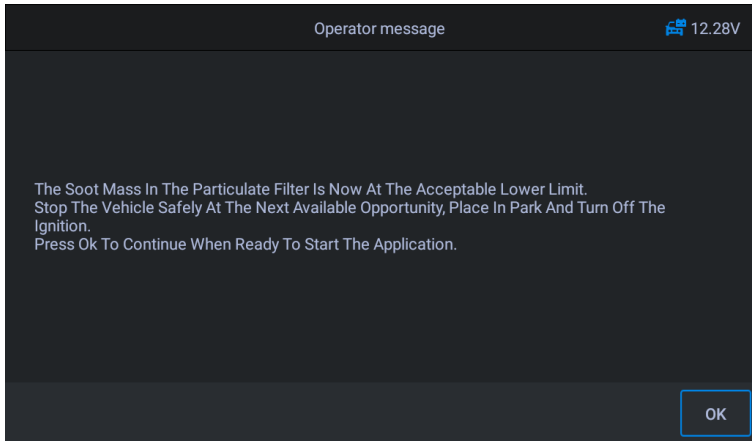

Figure 5-47 Sample DPF Service Function Screen 6

10. Application completed, press OK to exit.

5.9 Head Lamp

Head Lamp is about the headlamp maintenance, maintenance and other related operations (including AFS setting), and then perform this function for calibration.

Using **Jaguar** as an example:

If the vehicle has a headlamp replacement, the calibration of the headlamp leveling height sensor needs to be performed.

➤ To perform Head Lamp functions

1. Tap the **Service** application button from the CR MAX Job Menu.
2. Tap **Head Lamp** icon and wait for the vehicle manufacturer screen. Then tap **Jaguar** icon from the screen. Waiting for vehicle communication.
3. You can tap **Auto Identify** to acquire vehicle VIN information and tap **OK** to confirm. Or you can tap the **Vehicle Select** to choose the **correct vehicle according to the on-screen instructions**. See *Vehicle Identification* on page 14 for detail.

4. Select "lighting - headlamp control module system calibration" in the function list. The list may vary by vehicle.

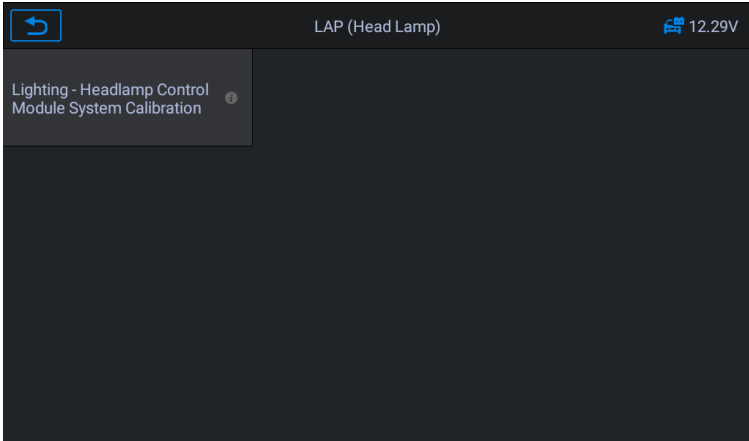

Figure 5-48 Sample Head Lamp Screen 1

5. Wait for the system communication, keep the vehicle stationary as required, and press [OK] to perform the system calibration operation. This process takes 30 seconds.

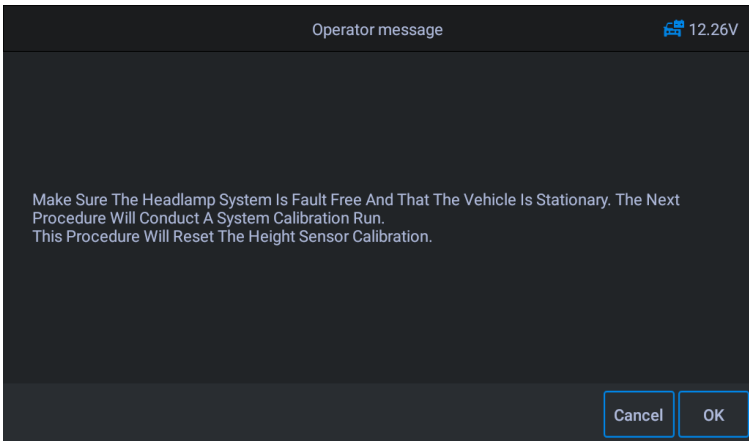

Figure 5-49 Sample Head Lamp Screen 2

6. Wait until the screen prompts "application completed" to complete the operation, and press [OK] to exit.

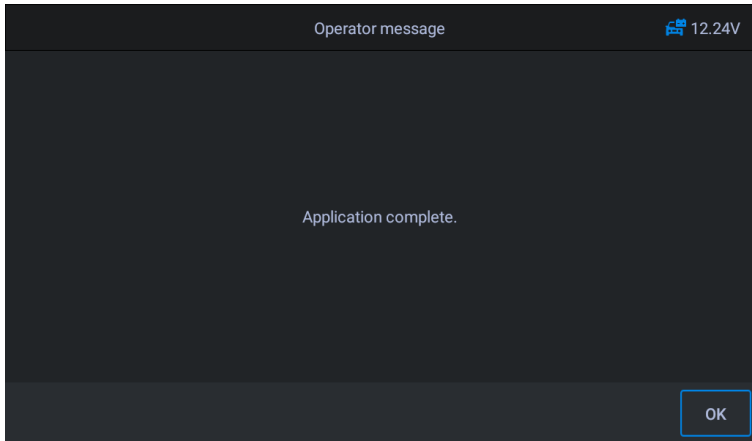

Figure 5-50 Sample Head Lamp Screen 3

5.10 Air Suspension

Air Suspension: After maintenance, replacement and other operations of the suspension height sensor are performed in all aspects, this function needs to be executed for suspension learning and calibration.

Using **Land Rover** as an example

There are several function lists in air suspension. Here, select "suspension system - air suspension inflation" as an example.

To perform Air Suspension functions

1. Tap the **Service** application button from the CR MAX Job Menu.
2. Tap **Air Suspension** icon and wait for the vehicle manufacturer screen. Then tap **Land Rover** icon from the screen. Waiting for vehicle communication.
3. You can tap **Auto Identify** to acquire vehicle VIN information and tap **OK** to confirm. Or you can tap the **Vehicle Select** to choose the **correct vehicle according to the on-screen instructions**. See *Vehicle Identification* on page 14 for detail.
4. Tap the needed service in the **Air Suspension** function list. The list

may vary by vehicle. Select the "Suspension System - Air Suspension Inflation" option in the function list.

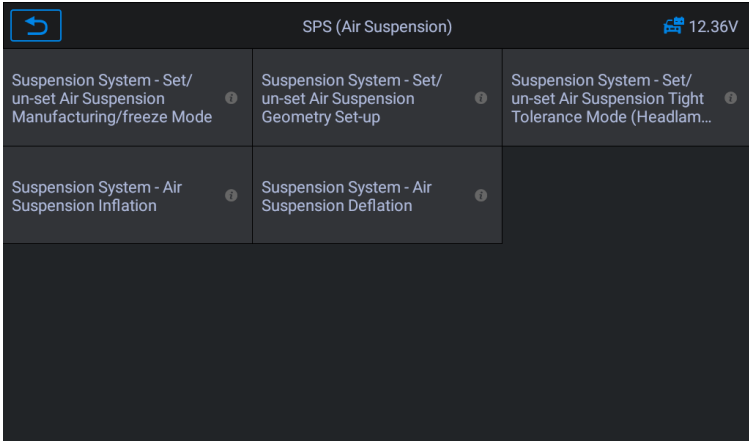

Figure 5-51 Sample Air Suspension Function Screen 1

5. Carefully read the operation information on the screen, this routine puts the chassis module into normal operation, thus inflating the air suspension. Follow the procedure and select [OK] to continue.

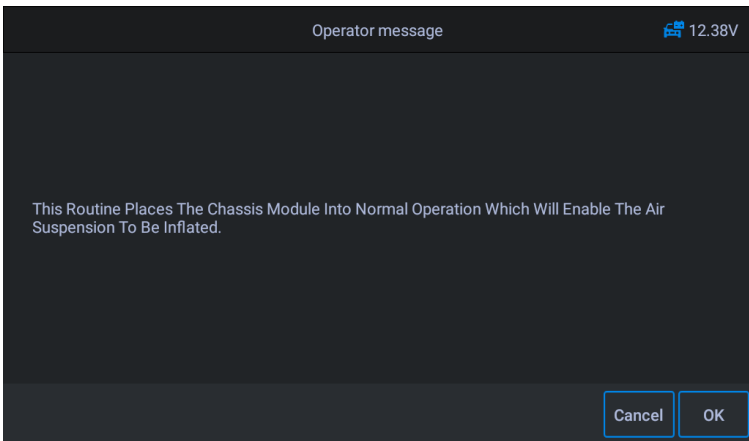

Figure 5-52 Sample Air Suspension Function Screen 2

Note!

During the procedure, the engine shall be off, and the supply voltage shall be 12.5v (standard). If The Voltage Is Less Than The Standard, Then The

Procedure May Fail.

6. Press OK to wait for the device to communicate, and then read the screen prompts to ensure that the inflation conditions are met.

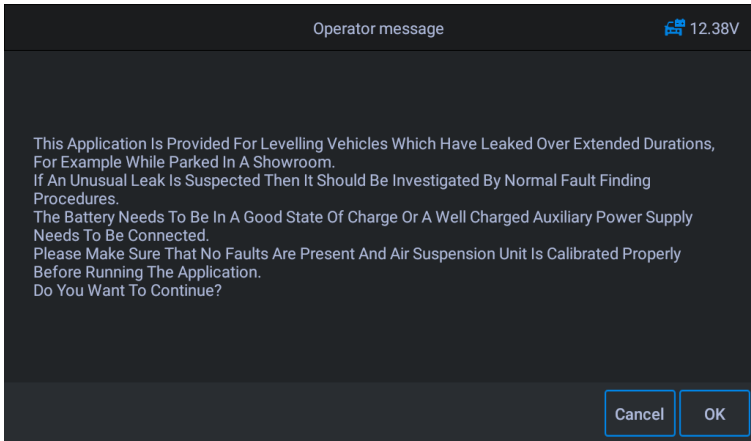

Figure 5-53 Sample Air Suspension Function Screen 3

7. If the conditions are met, the system will enter the communication state, and the air suspension will enter inflation. In this process, the program runs inflation, the screen will change. You can also tap the Cancel button to exit.

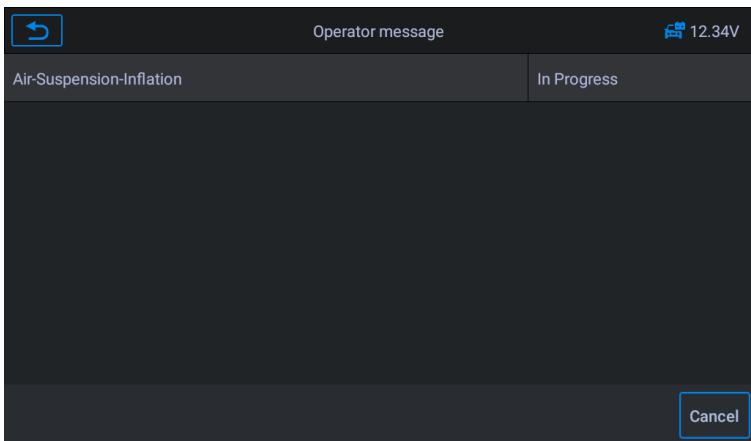

Figure 5-54 Sample Air Suspension Function Screen 4

8. Wait until the screen prompts "application completed" to complete the

operation, and press [OK] to exit.

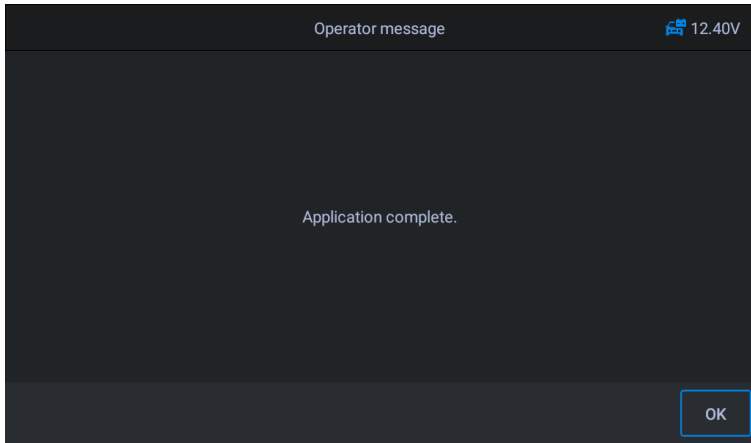

Figure 5-55 Sample Air Suspension Function Screen 5

5.11 TPMS programming service

The TPMS service function include displaying sensor IDs from the vehicle's ECU, inputting TPMS sensor replacement IDs and testing sensors.

Select tire pressure sensor replacement (Front right wheel sensor) as an example.

NOTE

- 1) This function will require the sensor ID be inputted on the screen.
 - 2) The sensor IDs can be read directly from the sensor or by using a sensor activation tool that can read the ID.
 - 3) Once the IDs have been entered, the vehicle may have to be driven at a certain speed for a certain time to complete procedure. Follow the instructions displays.
-

Select tire pressure sensor replacement (Front right wheel sensor) as an example. Using **Jaguar** as an example:

- Tire pressure sensor replacement:

During this application the wheel unit 8-bits identifications will need to be entered using the screens provided. The sensor identifications can be accessed by reading directly from the wheel unit or by using the identification reading tool. On completion, a specific road test will be required followed by the tire pressure monitor system confirmation application.

1. Tap the **Service** icon from the CR MAX Job Menu.
2. Tap **TPMS** icon and wait for the vehicle manufacturer screen. Then tap **Jaguar** icon from the screen. Waiting for vehicle communication.
3. You can tap **Auto Identify** to acquire vehicle VIN information and tap **OK** to confirm. Or you can tap the **Vehicle Select** to choose the **correct vehicle according to the on-screen instructions**. See *Vehicle Identification* on page 14 for detail.
4. **Perform tire pressure sensor replacement to go to the next step.**

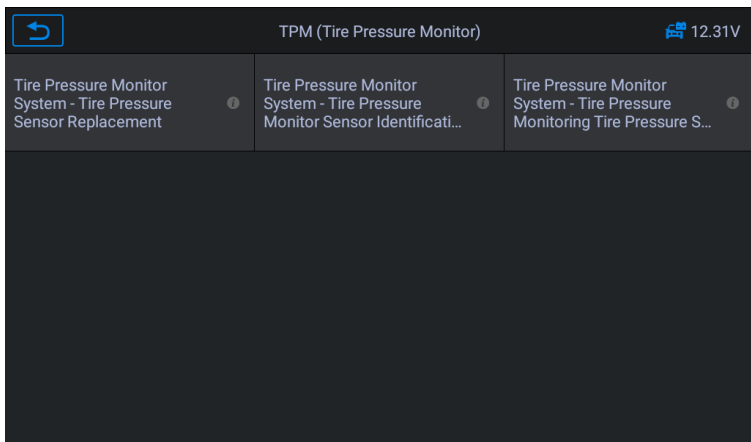

Figure 5-56 Sample TPMS Function Screen 1

5. The screen displays the initial value of the current sensor code, and press OK to proceed to the next step. Take the right front wheel sensor replacement as an example.

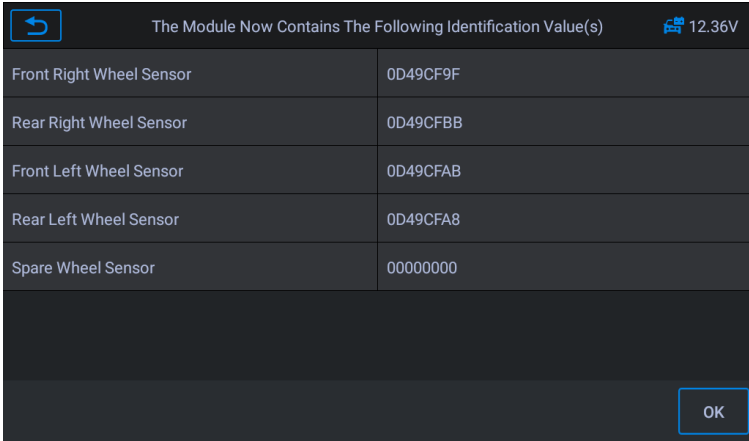

Figure 5-57 Sample TPMS Function Screen 2

6. Select the standard wheel with tire pressure sensor. Select the right front wheel sensor according to the screen.

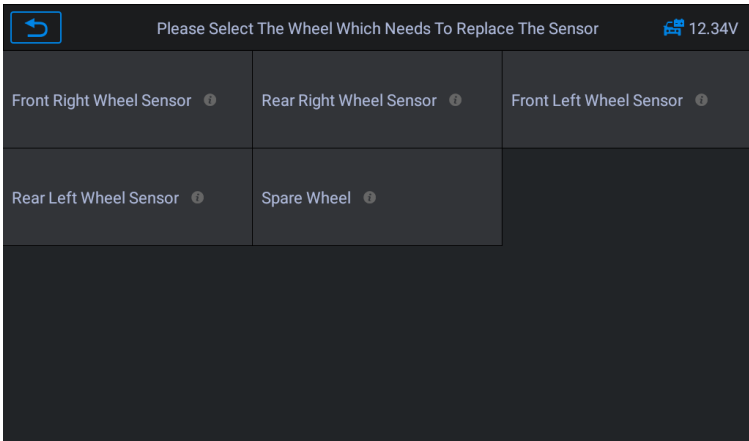

Figure 5-58 Sample TPMS Function Screen 3

7. Read the on-screen prompt carefully, which will tell you how to obtain the 8-digit sensor identification code.

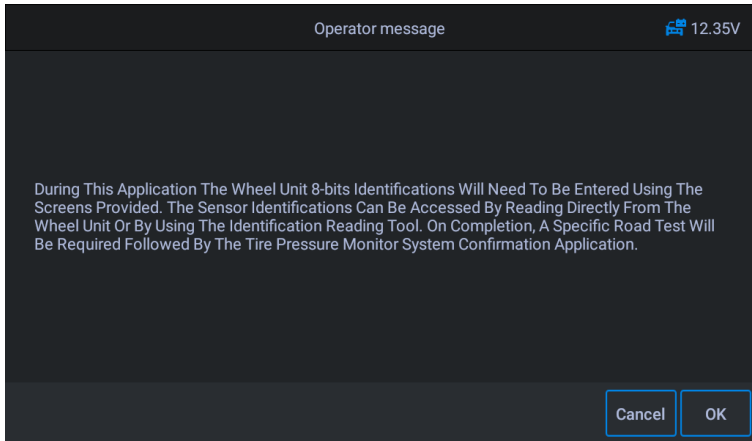

Figure 5-59 Sample TPMS Function Screen 4

8. Read the 8-digit sensor identification code from the replacement sensor.

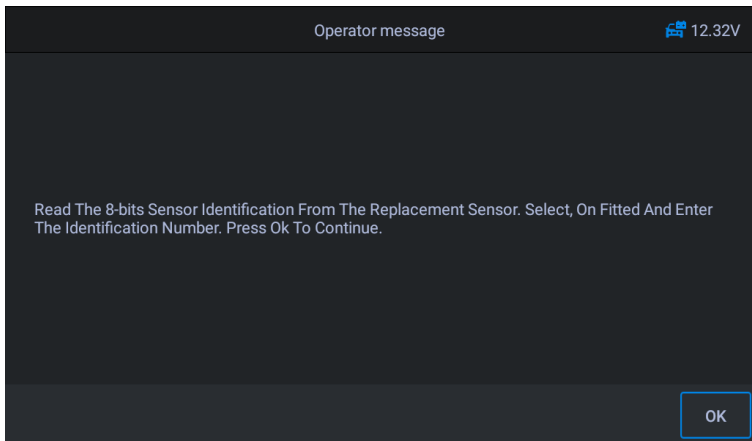

Figure 5-60 Sample TPMS Function Screen 5

9. Input 8-bits Sensor Identifications as required, and press [OK].

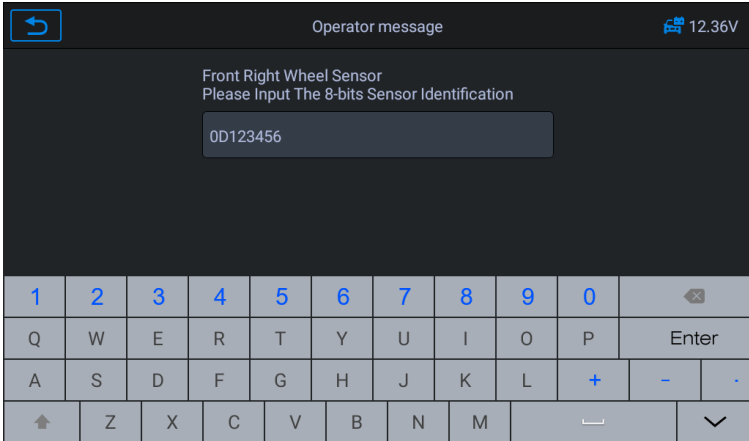

Figure 5-61 Sample TPMS Function Screen 6

10. After passing the 8-bit sensor identification test, carry out a specific road test.

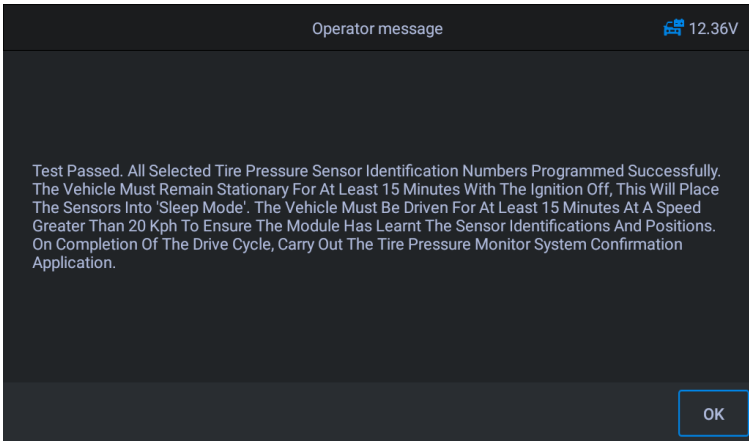

Figure 5-62 Sample TPMS Function Screen 7

11. After the driving cycle, confirm the tire pressure monitor system application.

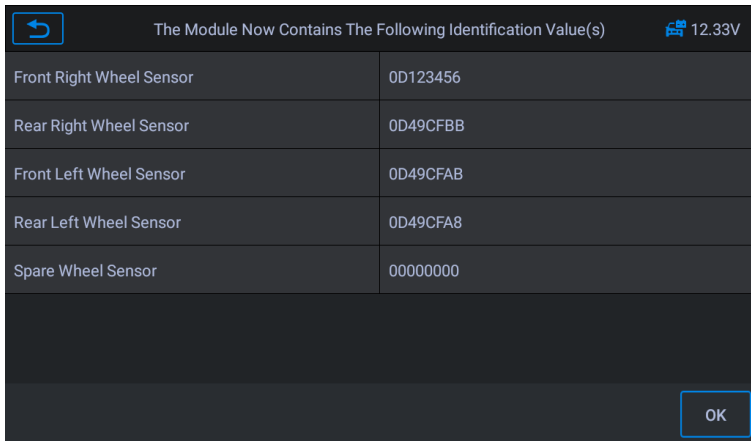

Figure 5-63 Sample TPMS Function Screen 8

NOTE

The vehicle must remain stationary for at least 15 minutes with the ignition off, this will place the sensors into sleep mode. The vehicle must be driven for at least 15 minutes at a speed higher than 20 kph to ensure the module has learned the sensor identifications and positions.

For other services, please follow the on-screen instructions to operate.

On completion of the drive cycle, carry out the tire pressure monitor system test application.

5.12 Gearbox Reset

After the gearbox is disassembled or repaired, it will cause shift delay or shock problems. At this time, this function needs to be executed to make the gearbox automatically compensate according to the driving conditions in order to achieve a more comfortable and more ideal shift quality.

Using **Benz** as an example:

To perform Gearbox Reset functions

1. Tap the **Service** application button from the CR MAX Job Menu.
2. Tap **Transmission** icon and wait for the vehicle manufacturer screen. Then tap **Benz** icon from the screen. Waiting for vehicle

communication.

3. You can tap **Auto Identify** to acquire vehicle VIN information and tap **OK** to confirm. Or you can tap the **Vehicle Select** to choose the **correct vehicle according to the on-screen instructions**. See *Vehicle Identification* on page 14 for detail.
4. Tap “Resetting the adaptation values” in the function list. The list may vary by vehicle.

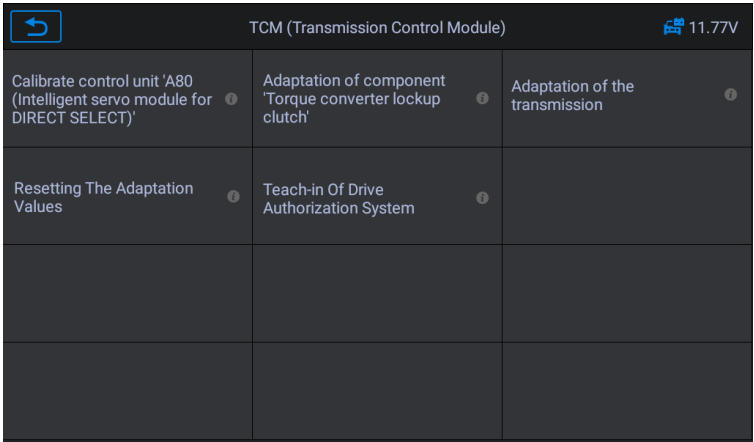

Figure 5-64 Sample Gearbox Reset Screen 1

5. In the next step, select "adaptation values of shift operations" reset the adaptation value of the gear.

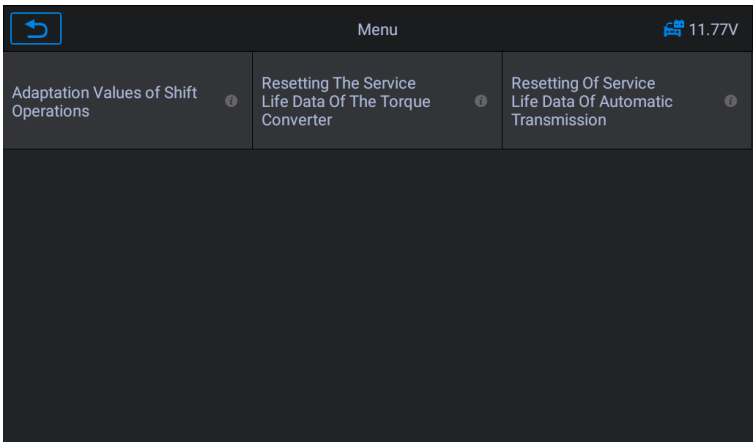

Figure 5-65 Sample Gearbox Reset Screen 2

6. Set ignition switch to on. Then Follow the on-screen instructions, carefully read the operation prompt information and determine whether to reset the adaptation value, if so, wait for the device to establish communication with the vehicle.

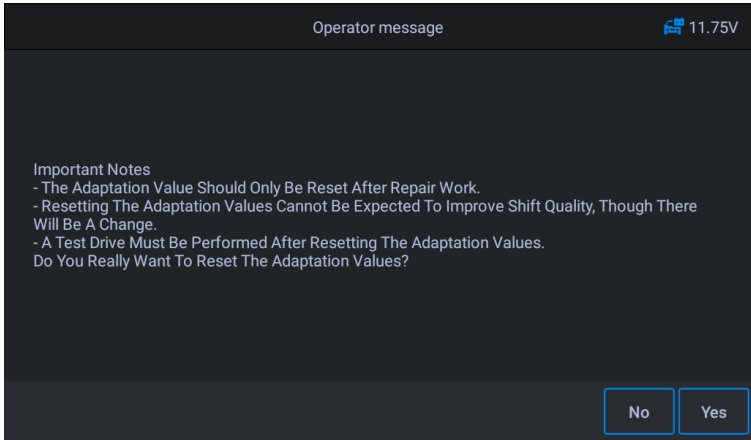

Figure 5-66 Sample Gearbox Reset Screen 3

7. Tap **Yes** and the device will send instructions until the operation is completed.

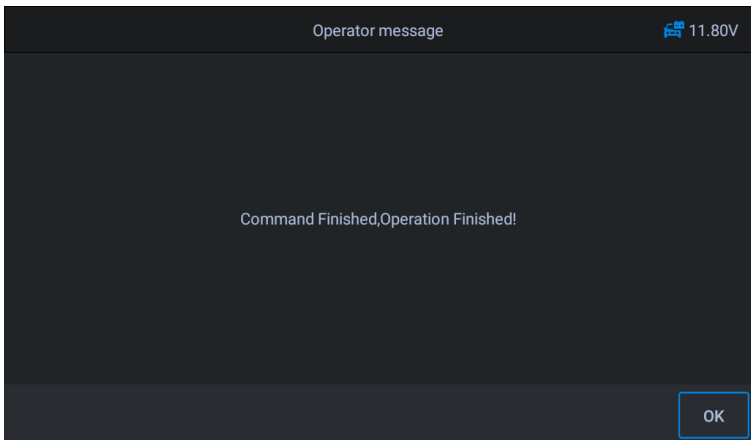

Figure 5-67 Sample Gearbox Reset Screen 4

5.13 Air conditioning service

After the refrigerant, blower pump, etc. in the air conditioner are replaced, the air conditioning system may not work normally. At this time, this function is needed to activate the air conditioner for a period of time to match the replaced refrigerant, blower pump and other automotive components.

Using **Benz** as an example:

To perform Air-conditioner service functions

1. Tap the **Service** application button from the CR MAX Job Menu.
2. Tap **Air conditioning service** icon and wait for the vehicle manufacturer screen. Then tap **Benz** icon from the screen. Waiting for vehicle communication.
3. You can tap **Auto Identify** to acquire vehicle VIN information and tap **OK** to confirm. Or you can tap the **Vehicle Select** to choose the **correct vehicle according to the on-screen instructions**. See *Vehicle Identification* on page 14 for detail.
4. Select "Breaking-in of refrigerant compressor" in the function list.

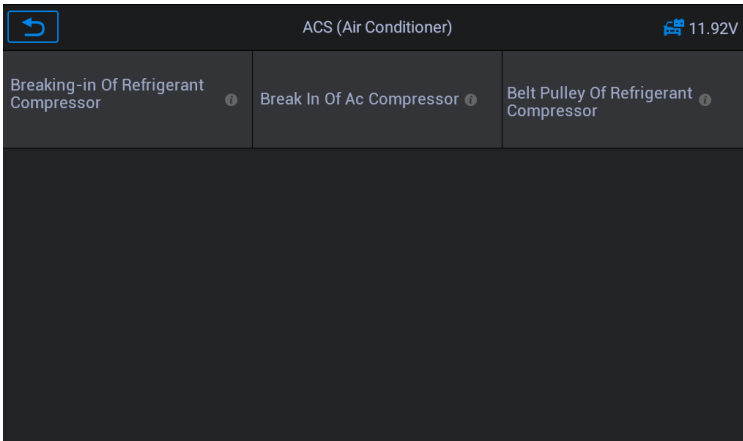

Figure 5-68 Sample Air conditioning service Screen 1

5. When a new refrigerator compressor is installed, it is necessary to

carry out procedures to match the refrigerant to be replaced.

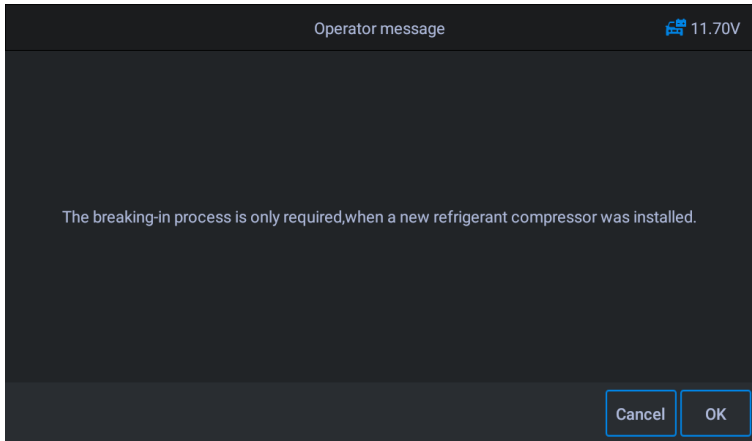

Figure 5-69 Sample Air conditioning Function Screen 2

6. Tap OK button to go to the next step and execute the vehicle as required. Continue to press the OK button until the instruction to complete the operation appears.

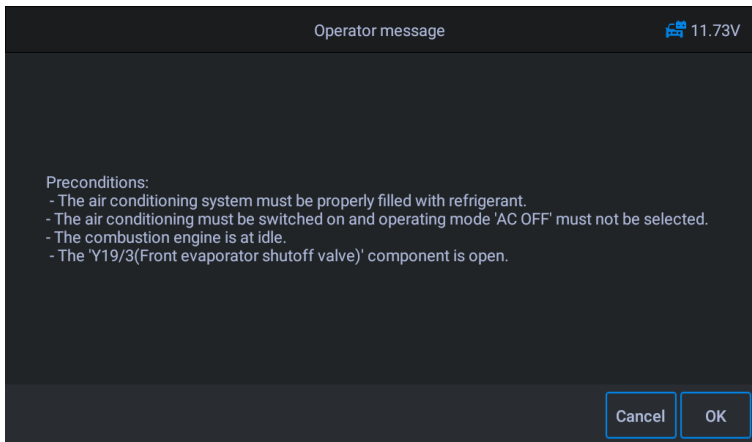

Figure 5-70 Sample Air conditioning Function Screen 3

7. Press [OK] to exit.

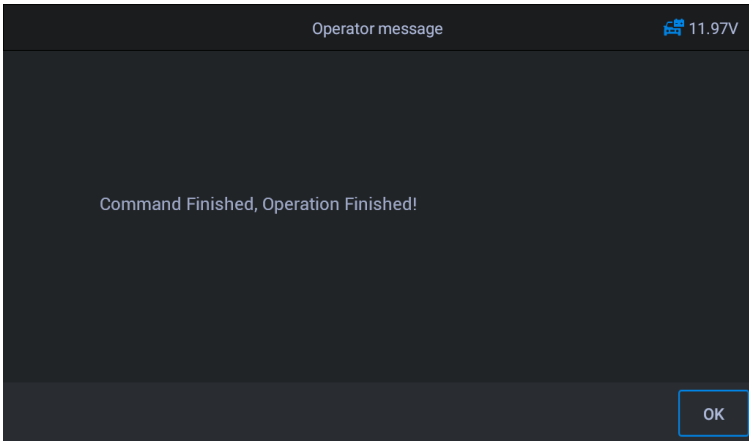

Figure 5-71 Sample Air conditioning Function Screen 4

5.14 Air Filter

The engine is a very precise machine part, and even the smallest impurities will cause the wear of the engine. Therefore, the air must be filtered by the air cleaner before entering the cylinder. Therefore, the disassembly, maintenance or replacement of the air filter will cause some particulate impurities in the air to enter the car parts. At this time, the air filter learning and matching functions need to be performed to make the air filter work normally.

Using **Benz** as an example:

To perform A / F Setting functions

1. Tap the **Service** application button from the CR MAX Job Menu.
2. Tap "**A / F Setting**" icon and wait for the vehicle manufacturer screen. Then tap **Benz** icon from the screen. Waiting for vehicle communication.
3. You can tap **Auto Identify** to acquire vehicle VIN information and tap **OK** to confirm. Or you can tap the **Vehicle Select** to choose the **correct vehicle according to the on-screen instructions**. See *Vehicle Identification* on page 14 for detail.

4. Perform resetting the air filter learning value.

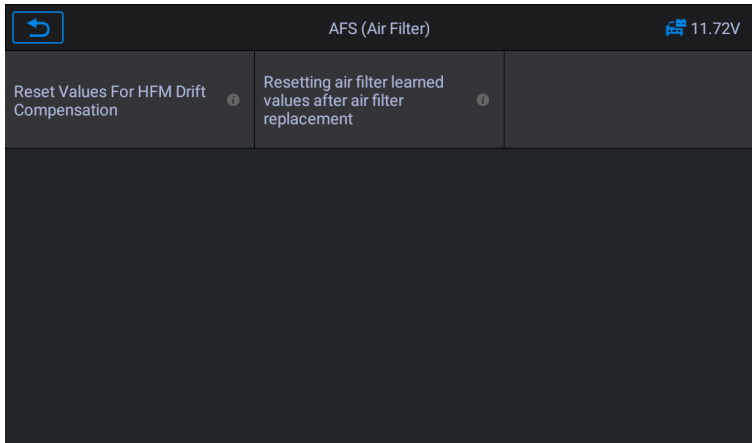

Figure 5-72 Sample Air Filter Screen 1

5. Screen prompt: Teach-in process after replacement of component "Air Filter", Press OK to continue.

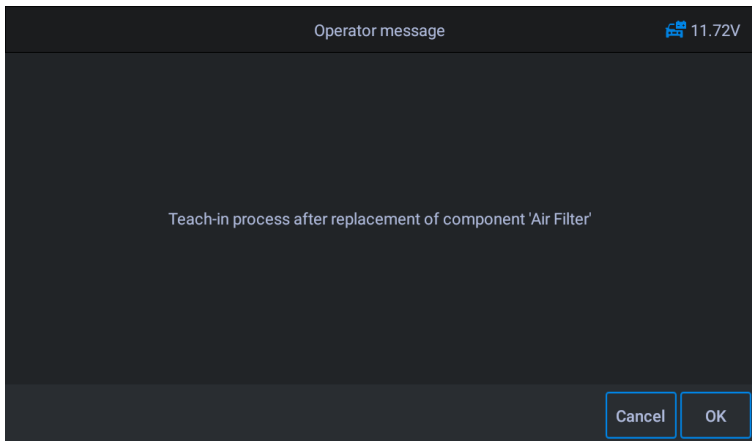

Figure 5-73 Sample Air Filter Screen 2

6. Follow the prompts until the instruction to complete the command operation appears.

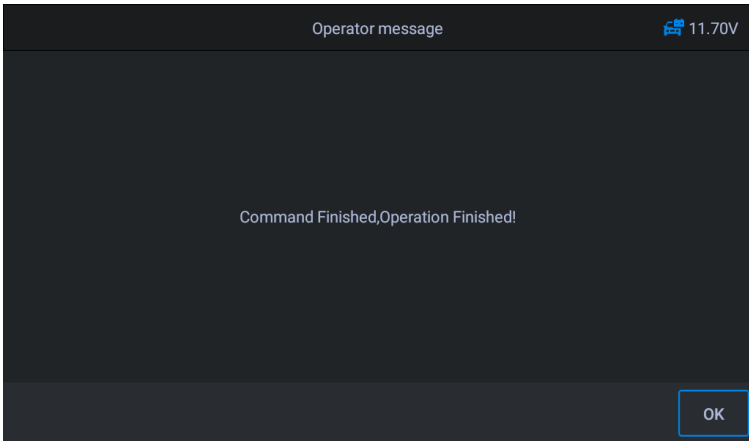

Figure 5-74 Sample Air Filter Screen 3

7. Press [OK] to exit.

5.15 Fuel Pump

After the fuel pump is disassembled, repaired or replaced, it may cause the fuel pump to be unable to continuously provide fuel to the fuel injection nozzle. At this time, the function needs to be executed to activate the replaced fuel pump so that the car can start to inject fuel normally and make the engine achieve the ideal Running status.

Using **Benz** as an example:

To perform Activate fuel pump functions:

1. Tap the **Service** application button from the CR MAX Job Menu.
2. Tap "**Fuel Pump**" icon and wait for the vehicle manufacturer screen. Then tap **Benz** icon from the screen. Waiting for vehicle communication.
3. You can tap **Auto Identify** to acquire vehicle VIN information and tap **OK** to confirm. Or you can tap the **Vehicle Select** to choose the **correct vehicle according to the on-screen instructions**. See *Vehicle Identification* on page 14 for detail.

4. Select Activate fuel pump. Follow the screen prompts for the next step.



Figure 5-75 Sample Fuel Pump Screen 1

 **Note:** Requirements for teach-in process: Ignition on, combustion engine at standstill, accelerator pedal not operated. Please switch the engine off!

5. In the next step, the screen will show that the status of the fuel pump is not activated. Tap OK, the equipment will issue a command to activate the fuel pump.

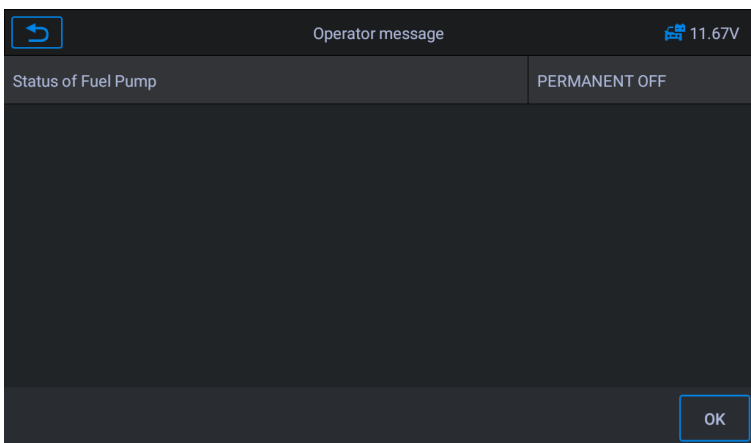

Figure 5-76 Sample Fuel Pump Screen 2

6. Wait for the screen to display the application is complete. Press [OK] to exit.

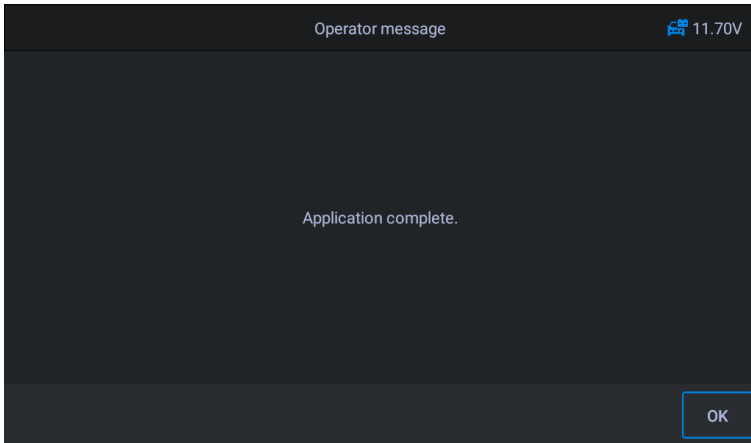

Figure 5-77 Sample Fuel Pump Screen 3

5.16 Engine Idle

This correction can be executed when the idle speed fault is resolved. Adjust the engine speed of the car at idle speed.

Using **Benz** as an example:

1. Tap the **Service** application button from the CR MAX Job Menu.
2. Tap “**Engine Idle**” icon and wait for the vehicle manufacturer screen. Then tap **Benz** icon from the screen. Waiting for vehicle communication.
3. You can tap **Auto Identify** to acquire vehicle VIN information and tap **OK** to confirm. Or you can tap the **Vehicle Select** to choose the correct vehicle according to the on-screen instructions. See *Vehicle Identification* on page 14 for detail.
4. Select “Idling specified speed with selector lever in position P or N”. Turn on the vehicle ignition and wait for communication.

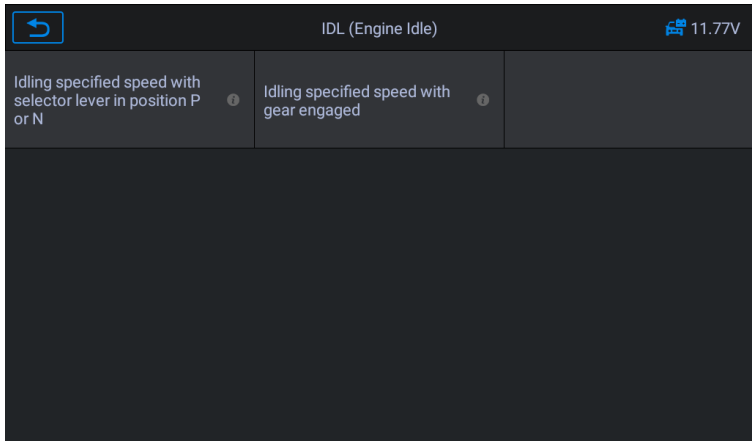

Figure 5-78 Sample Engine Idle Function Screen 1

5. There will be a message on the screen: the engine is running, the selector lever is at P or N, and the coolant temperature is higher than 70.

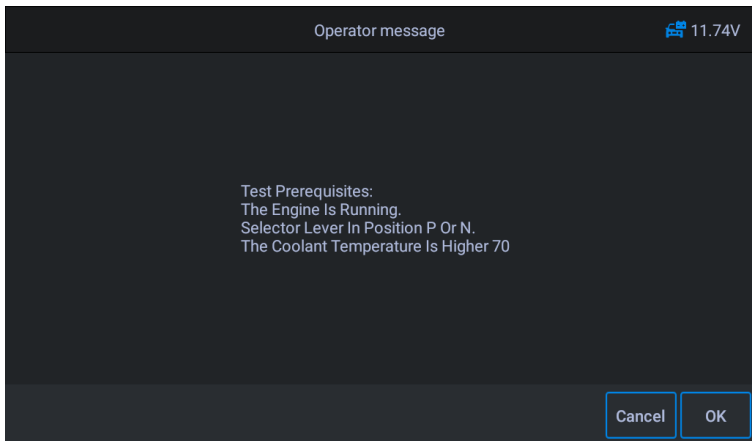

Figure 5-79 Sample Engine Idle Function Screen 2

6. The engine idle speed can be adjusted in the next step, tap the [+] or [-] button to adjust the engine idle speed.

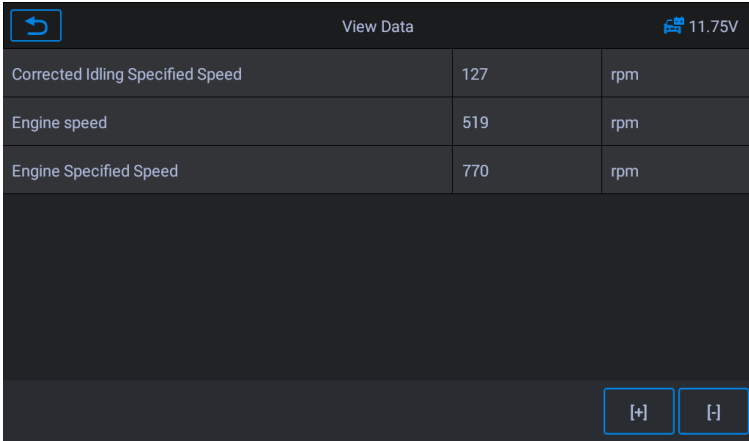

Figure 5-80 Sample Engine Idle Function Screen 3

7. Follow the prompts on the screen to turn the ignition on or off until the procedure is complete.

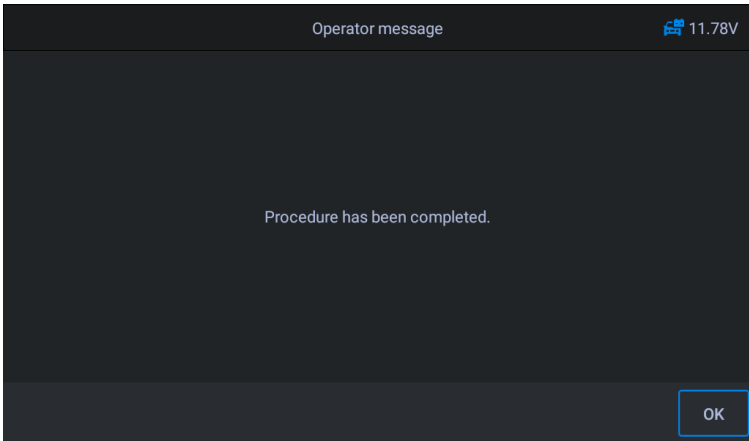

Figure 5-81 Sample Engine Idle Function Screen 4

8. Press [OK] to exit.

5.17 Body stability

Learning and calibration after replacing the body stability control unit and other related components, such as: lateral acceleration sensor for

active roll stabilization system, BAS brake assist system, ESP electronic stability program, calibration of yaw rate / lateral and longitudinal acceleration sensors, pedal angle Sensors, etc.

Using **Benz** as an example:

1. Tap the **Service** application button from the CR MAX Job Menu.
2. Tap “**Body stability**” icon and wait for the vehicle manufacturer screen. Then tap **Benz** icon from the screen. Waiting for vehicle communication.
3. You can tap **Auto Identify** to acquire vehicle VIN information and tap **OK** to confirm. Or you can tap the **Vehicle Select** to choose the correct vehicle according to the on-screen instructions. See *Vehicle Identification* on page 14 for detail.
4. Select “learning process” option on the screen and turn on ignition.

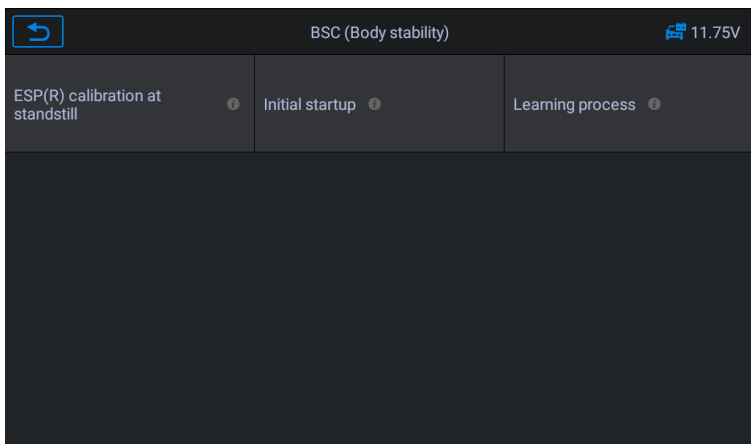

Figure 5-82 Sample Body Stability Function Screen 1

5. Carefully read the prompt information on the screen. Before performing this operation, complete the BAS brake assist system, and replace the ESP and BAS press units and other components.

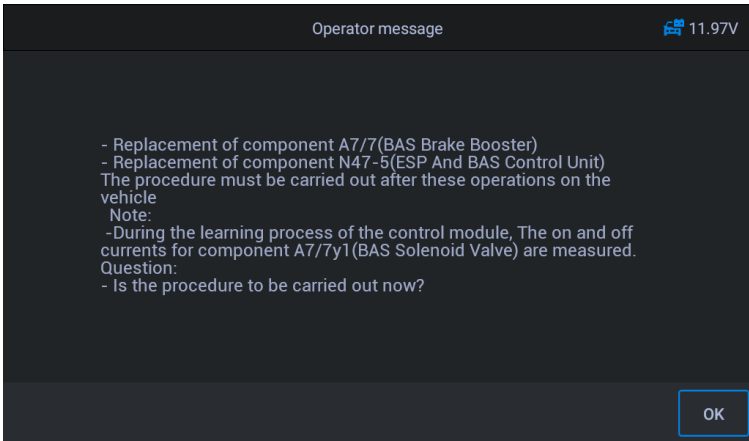

Figure 5-83 Sample Body Stability Function Screen 2

6. Press [OK] to the next step, this process takes a long time, until the completed instruction is prompted.

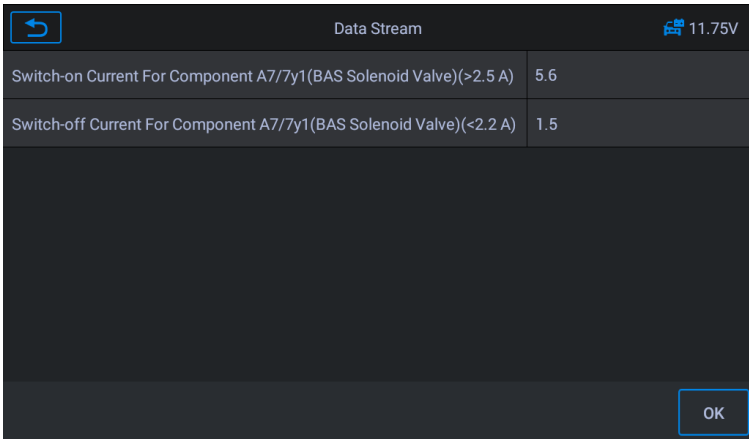

Figure 5-84 Sample Body Stability Function Screen 3

7. Press [OK] to exit.

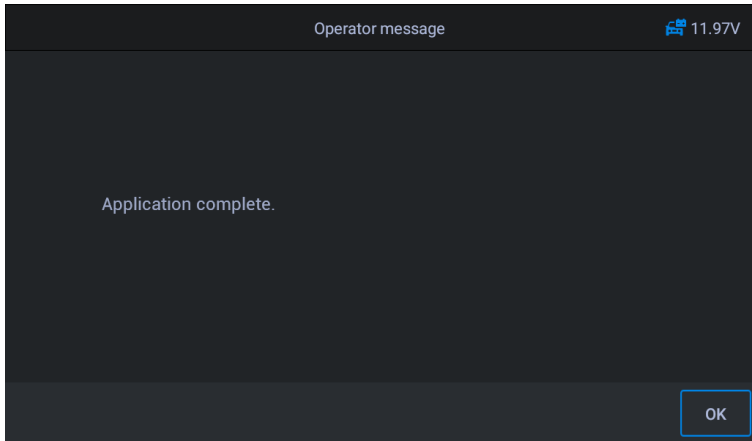

Figure 5-85 Sample Body Stability Function Screen 4

5.18 Door

After repairing or replacing the window lift motor, it is necessary to perform relevant functions for calibration.

Using **Jaguar** as an example:

➤ **Door Window Calibration:**

This routine learns the top position of the door window glass, which enables pinch protection and one touch up function. The door window glass position can be learned by executing this routine.

1. Tap the **Service** application button from the CR MAX Job Menu.
2. Tap "**Door**" icon and wait for the vehicle manufacturer screen. Then tap **Benz** icon from the screen. Waiting for vehicle communication.
3. You can tap **Auto Identify** to acquire vehicle VIN information and tap **OK** to confirm. Or you can tap the **Vehicle Select** to choose the correct vehicle according to the on-screen instructions. See *Vehicle Identification* on page 14 for detail.
4. Select body system, door and window calibration, and on the next screen calibrate the drive's doors and windows.

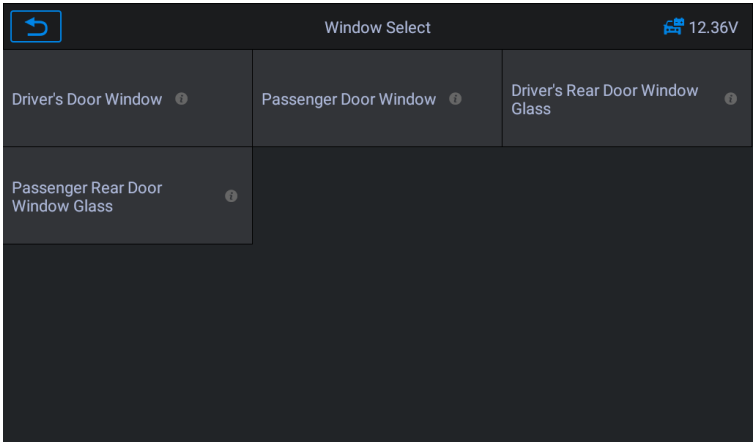

Figure 5-86 Sample Door Function Screen 1

5. The position of the door window glass can be learned by performing this routine. Follow the screen prompts step by step.

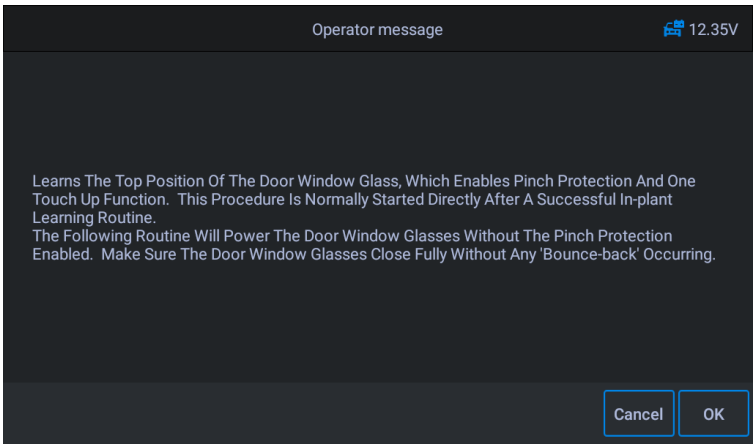

Figure 5-87 Sample Door Function Screen 2

6. Until the screen prompts that the operation is completed, press the OK to exit.

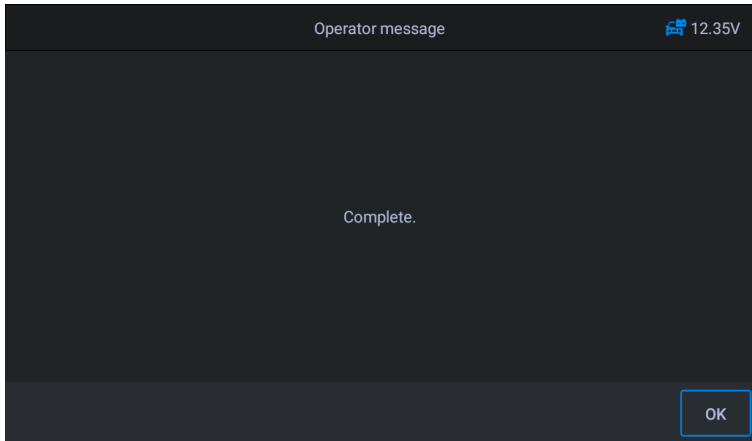

Figure 5-88 Sample Door Function Screen 3

5.19 Seat

After repairing or replacing the seat position drive motor, it is necessary to perform relevant functions for calibration.

Using **Jaguar** as an example:

➤ **Driver's Seat Calibration:**

The following routine will restore all the seat axis position values to default for the driver's seat module.

1. Tap the **Service** application button from the CR MAX Job Menu.
2. Tap "**Seat**" icon and wait for the vehicle manufacturer screen. Then tap **Jaguar** icon from the screen. Waiting for vehicle communication.
3. You can tap **Auto Identify** to acquire vehicle VIN information and tap **OK** to confirm. Or you can tap the **Vehicle Select** to choose the correct vehicle according to the on-screen instructions. See *Vehicle Identification* on page 14 for detail.
4. **Calibrate the driver's seat.**

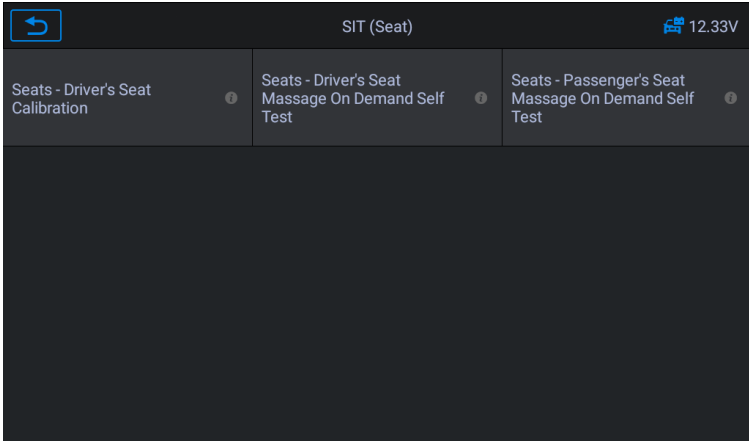

Figure 5-89 Sample Seat Function Screen 1

5. The program will restore all seat axis position values of the driver's seat module to the default values. Reset all adaptive values.

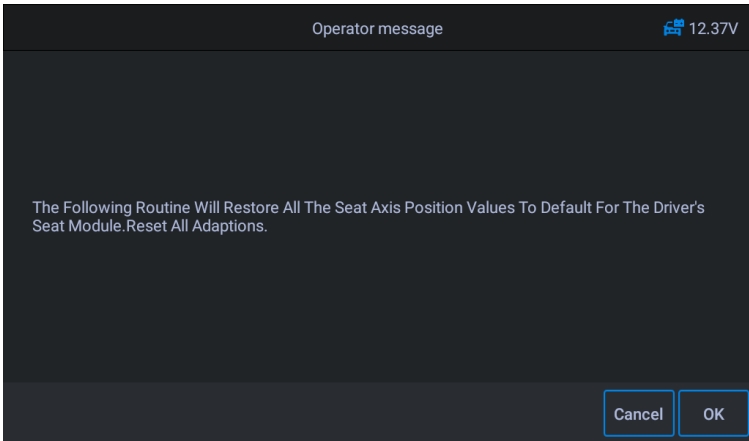

Figure 5-90 Sample Seat Function Screen 2

6. Make sure that the area around the seat is free of any objects that will hinder full movement and do not sit on the seat during operation.

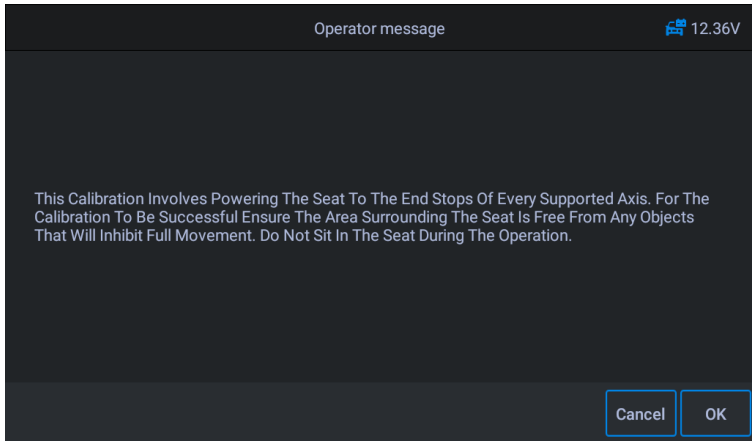

Figure 5-91 Sample Seat Function Screen 3

7. Tap OK according to the screen prompt to continue until the screen prompt is completed.

➤ **Passenger's Seat Calibration:**

The following routine will restore all the seat axis position values to default for the passenger seat module.

Note:

Different models will have different menu modes. This manual is for reference. Everything in kind shall prevail. If there is any increase or decrease in the function of the product, the actual product shall prevail.

6 User Data

The **User Data** application is used to store, print, and review the saved files. Most operations are controlled through the toolbar.

Selecting the User Data application opens the file system menu. Different file types are sorted separately under different options, there are six types of information files to be viewed or played back.

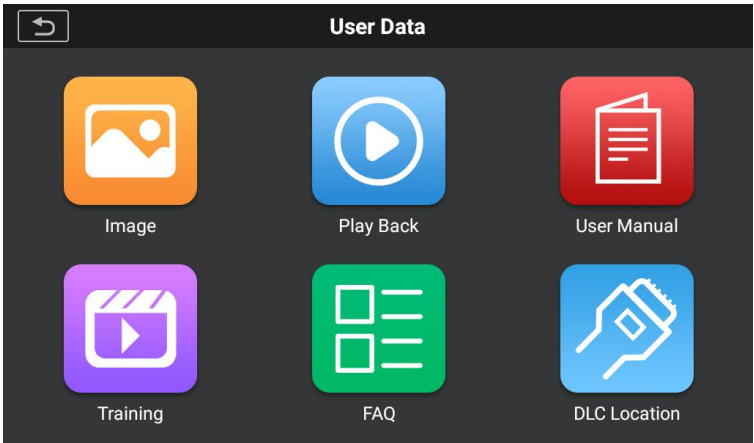

Figure 6-1 Sample User Data Main Screen

User Data Operations are based on toolbar controls. Details are explained in the following sections.

6.1 Image Files

The Image section contains all captured screenshot images. The image section allows you to view all the screenshots.

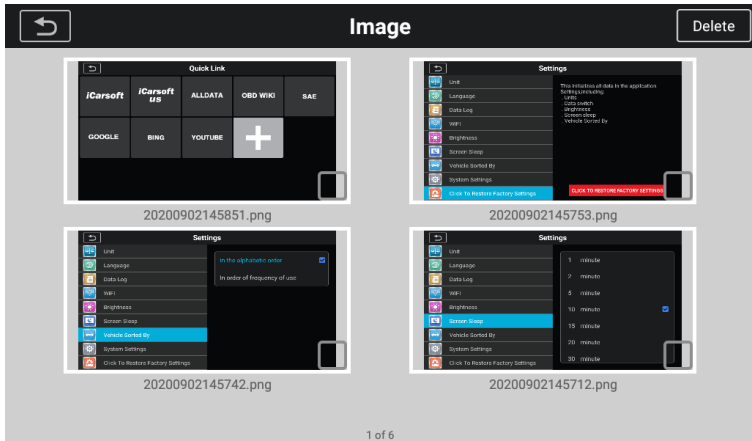

Figure 6-2 Sample Image Screen

6.2 Play Back

The playback section allows you to view diagnostic data, live data, and fault codes on the system.

➤ **To view live data:**

1. Tap the **Play back** icon on the User Data application. The screen display the data list of diagnostic data, live data, and fault codes.

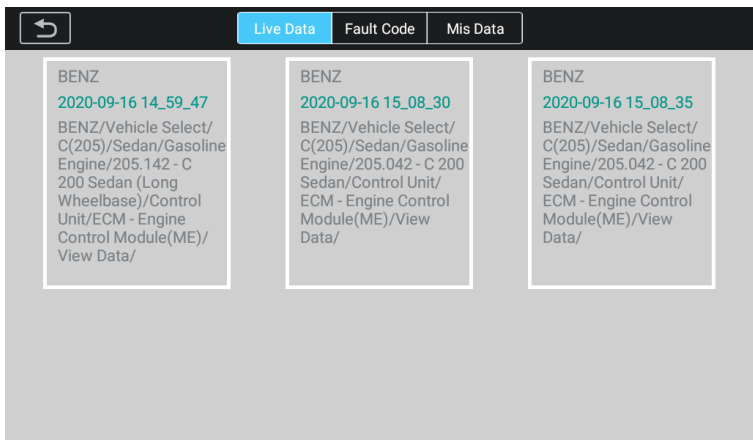
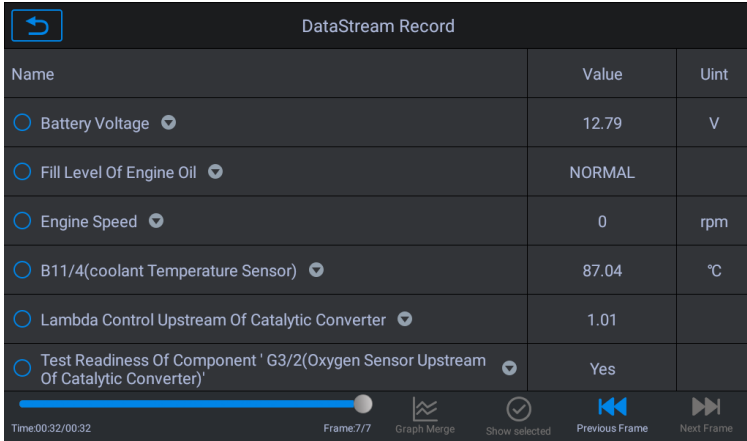

Figure 6-3 Sample Play Back Screen 1

2. Select a list, the screen will enter the data flow recording interface.



Name	Value	Unit
<input type="radio"/> Battery Voltage	12.79	V
<input type="radio"/> Fill Level Of Engine Oil	NORMAL	
<input type="radio"/> Engine Speed	0	rpm
<input type="radio"/> B11/4(coolant Temperature Sensor)	87.04	°C
<input type="radio"/> Lambda Control Upstream Of Catalytic Converter	1.01	
<input type="radio"/> Test Readiness Of Component ' G3/2(Oxygen Sensor Upstream Of Catalytic Converter)'	Yes	

Time:00:32/00:32 Frame:7/7 Graph Merge Show selected Previous Frame Next Frame

Figure 6-4 Sample Play Back Screen 2

6.3 User Manual

The user manual section stores and displays the user manual, and saves the data PDF file to view the user manual of this device. In this section, use the standard adobe reader application to view and edit the file. Please refer to the relevant adobe reader manual for instructions.

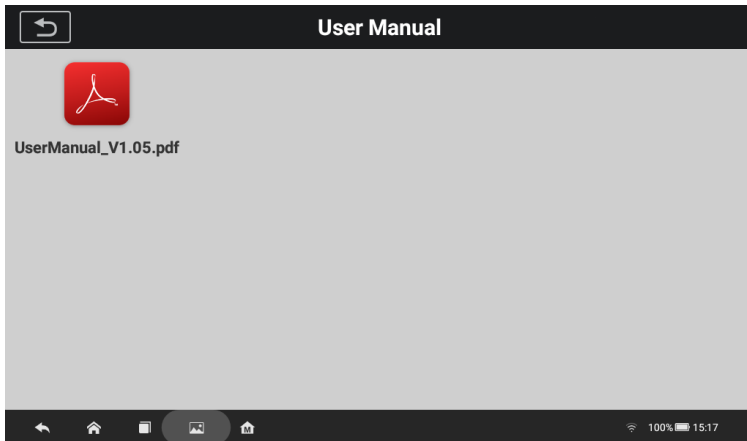

Figure 6-5 Sample User Manual Screen

6.4 Training

The training section provides videos of operating applications to facilitate customers to quickly understand the operating functions of CR MAX..



Figure 6-5 Sample Training Screen

6.5 FAQ

The FAQ section provides comprehensive answers to the most frequently asked questions of various vehicle models.

The FAQ option provides the user's Q & A documentation, in PDF format, to view the user's FAQs. In this section, use the standard adobe reader application to view and edit files. For instructions, refer to the relevant adobe reader manual.



Figure 6-6 Sample FAQ Screen

6.6 Data Link Connector (DLC) Location

This function is to provide the location of the data link connector (DLC), represented by A, B, C, D, E respectively.



Figure 6-7 Sample DLC Location Screen

7 Upgrade

The Update application allows you to download the latest released software. The updates can improve the CR MAX applications' capabilities, typically by adding new tests, new models, or enhanced applications.

The tablet automatically searches for available updates for the CR MAX software when it is connected to the internet. Any updates that are found can be downloaded and installed on the device. This section describes installing an update to the CR MAX System.

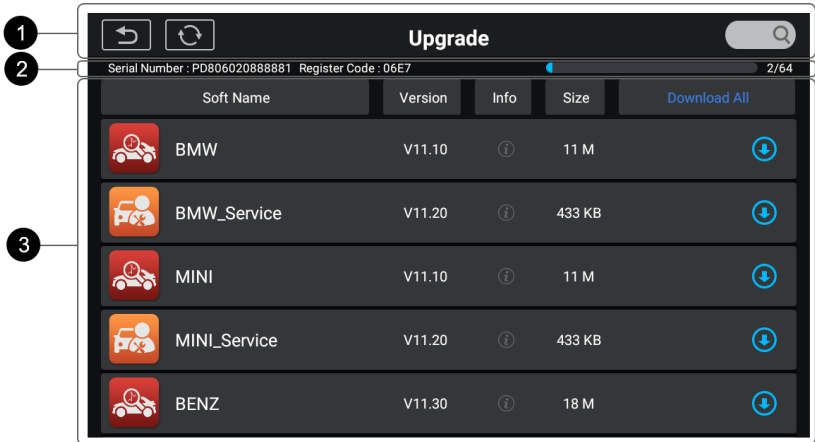

Figure 7-1 Sample Update Screen – for CR MAX

① Navigation and Controls

- Home Button – returns to the CR MAX Job Menu.
- Update All – downloads all available updates.
- Search Bar – search specific update item by inputting the file name,
 - For example: a vehicle make.



② Status Bar

- Left Side – displays the CR MAX device model information and

serial number.

- Right Side – displays an update progress bar indicating the completion status.

③ Main Section

- Left Column –displays the diagnostic function icon and service function icon and the name of the software;
- Middle Column –displays a summary of software changes, including software version, detailed information, and size. Tap  button to open the information screen to view detailed information. Tap the  button to turn it off.
- Right Column – controls software update. According to the status of the software download, a different titled button displays.
 - a) Tap the download icon to update the item you want to update.
 - b) Tap **Pause** to suspend the software update.
 - c) Tap **Continue** to resume updating the software.

➤ To update the diagnostic software and service software

1. Make sure the Display Tablet is connected to a power source with stable access to the internet.
2. Tap the **Upgrade** application button from the CR MAX Job Menu; or tap the update notification message when received; or tap the **Upgrade** icon on Vehicle Menu in Diagnostics application. The Update application screen displays.
3. Check all available updates:
 - If you decide to update all items of the software, please tap the "Download All" button.
 - If you only want to update one or some of the item(s), tap the **Update** button on the right column of the specific item(s).
4. Tap the **Pause** button to suspend the update. Tap **Continue** to

resume the update. The update will resume from the point at which it was paused.

5. The firmware will be installed automatically once its download has completed. The previous version will be replaced.







8 Shop Information

The Shop Manager application manages the workshop information including customer information records and test vehicle history records. There are three main functions available:

- **Vehicle History**
- **Workshop Information**
- **Customer Information**

The operations of these functions of the Shop Manager application are controlled by the toolbar buttons, which are listed and described in the table below:

Table 8-1 Top Toolbar Buttons in Shop Manager

Button	Name	Description
	Back	Cancel the current operation and return to the previous screen.
	Add Account	Tap this button to create a new customer account file.
	Save	Complete editing and save the file.
	Delete	Tap this button to delete the selected customer information and vehicle record.
	Modify edit and save	Tap this button to save the modified customer information and vehicle information.
	Add Customer Notes	Tap this button to open a note form. New customer notes can be added.

8.1 Workshop Info

Use the Workshop Information form to edit, input and save the detailed workshop information, such as shop name, address, phone number and other remarks, which when printing vehicle diagnostic reports and other

associated test file, will display as the header of the printed documents.

The screenshot shows a mobile application interface titled "WorkShop Info". It features a dark header bar with a back arrow on the left and a save icon on the right. Below the header, there is a form with several input fields. The fields are arranged as follows: "Shop name" with value "ffgg"; "Address" with value "dfffghhy"; "Zip code" with value "12569874"; "Contact" with value "fghbvcmjni"; "Tel" with value "45698523698"; "Fax" with value "456321789"; "Website" with value "www.ffff.com"; "E-mail" with value "44078965@qq.com"; and "Remark" with value "aaaaaassssdddddffffggggh". A red dot is positioned at the end of the Remark field.

Figure 8-1 Sample Workshop Information Sheet

➤ **To edit the Workshop Information sheet**

1. Tap the **Shop Info** application on the CR MAX Job Menu.
2. Select **Workshop Information**.
3. Tap on each field to input the appropriate information.
4. Tap the Save button in the upper right corner to save the updated workshop information table, or tap the back button in the upper left corner to exit without saving.

8.2 Customer Info

Use the Customer Manager function to create and edit customer accounts and correlate with the associated test vehicle history records.

➤ **To create a customer account**

1. Tap the **Shop Info** application on the CR MAX Job Menu.
2. Select **Customer Info**.
3. If a customer adds customer information, tap the **Add Account** button in the upper right corner. An empty information form

displays, then tap each field to input the appropriate information. Tap the back button to cancel.

The image shows a mobile application screen titled "Customer Info". At the top left is a back arrow icon, and at the top right is a save icon. Below the title is a profile picture placeholder labeled "Name". Underneath is a single-line text input field for "Address". Below that are two columns of input fields: "Tel" and "Website" on the left, and "Zip code" and "E-mail" on the right. At the bottom of the form is a single-line text input field for "Remark". At the very bottom is a button with a plus sign and the text "Add new vehicle information".

Figure 8-2 Sample Customer Info Sheet 1

NOTE

Required fields are noted.

4. Tap the **Save** button in the upper right corner to save the updated workshop information table, or tap the **back** button in the upper left corner to exit without saving.

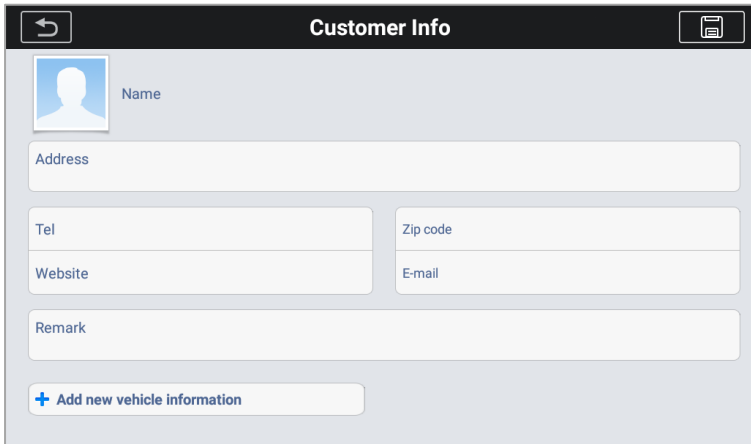
➤ **To edit a customer account**

1. Tap the **Shop Info** application on the CR MAX Job Menu.
2. Select **Customer Info**.
3. Select a customer account by tapping the corresponding name card. A Customer Information sheet displays.

Figure 8-3 Sample Customer Info Sheet 2

4. Tap on the input field that needs to be altered or supplemented, and enter updated information.
5. Tap the **Modify edit and save** button on the top toolbar to save the updated information, or tap the **Back** button on the top toolbar to exit without saving.

➤ **To delete a customer account**

1. Tap the **Shop Info** application on the CR MAX Job Menu.
2. Select **Customer Info**.
3. Select a customer account by tapping the corresponding name card. A Customer Information sheet displays.
4. Tap the **Delete** button on the top toolbar. A confirmation message displays.
5. Tap **Yes** to confirm the command, and the account is deleted. Tap **Cancel** to cancel the request.

8.2.1 Customer Notes

Use the Customer Notes function to add customer text record.

➤ **To access Customer Notes**

1. Tap the **Shop Info** application on the CR MAX Job Menu.
2. Select **Customer Info** or **Vehicle History**.
3. Select a customer account by tapping the corresponding name card. A Customer Information sheet displays (if **Customer Info** is selected). Or, select a vehicle history record item to open the Historical Test record sheet (if **Vehicle History** is selected).
4. Tap the **Add Customer Notes** button on the top bar. Now the **Customer Notes** interface is displayed.

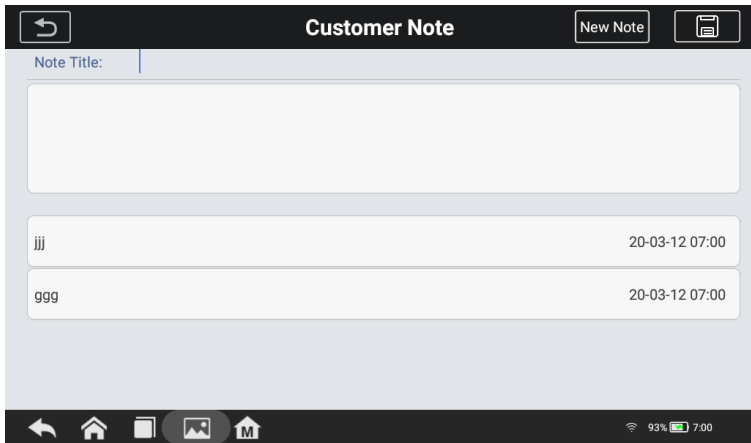

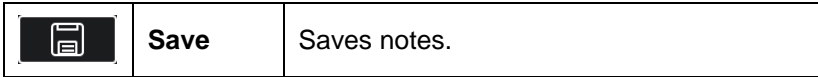

Figure 8-4 Sample Customer Notes Screen

- 1) **Functional Buttons** – navigates and performs various actions.
- 2) **Main Section** – displays the note list on the left column and the detail information of the selected note displays on the right column.

Table 6-2 Function Buttons in History Notes

Button	Name	Description
	Back	Cancel the current operation and return to the previous screen.
	New Note	Tap this button to quickly clear the information and create a new record



- **To add a note in Customer Notes**
 1. Access Customer Notes. An edit window displays.
 2. Tap on the Title bar to input a note title.
 3. Tap on the blank space below to edit a text note or remark.
 4. Select the new note button at the top to clear the current note and re-enter the new note.
 5. Tap **Save** to save the note; tap **Back** button to exit without saving.
 6. Select historical notes and tap ⊗ to delete. Or modify the note information

8.3 Vehicle History

This function stores test vehicle history records, including vehicle information and the retrieved DTCs from previous diagnostic sessions. All information is displayed in summarized details. Tap on a record to resume a diagnostic session on a “stored vehicle”.

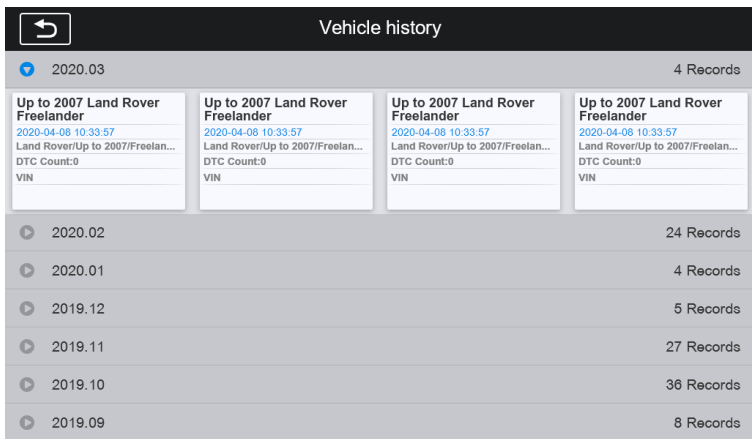

Figure 8-5 Sample Vehicle History Screen

➤ **To activate a test session for the recorded vehicle**

1. Tap the **Shop Info** application on the CR MAX Job Menu.
2. Select **Vehicle History**
3. Or, tap the vehicle record thumbnail to view record.
4. A Historical Test record sheet displays, check the recorded information of the recorded test vehicle, and tap the Diagnostics button on the upper right corner.
5. The vehicle's Diagnostics screen displays a new diagnostic session.

8.3.1 Historical Test Record

The Historical Test record sheet is a detailed data form that includes general vehicle information such as vehicle year, make and mode. The form also includes retrieved DTC from previous test and all information manually inputted by the technician.

➤ **To edit the Historical Test record sheet**

1. Tap the **Shop Info** application on the CR MAX Job Menu.
2. Select **Vehicle History**.
3. Select the specific vehicle history record thumbnail from the main section. The Historical Test record sheet displays.
4. Tap the **Edit** button to start editing.
5. Tap on each item to input the corresponding information or add relevant files or images.

 **NOTE**

The vehicle VIN number, or license and the customer information account are correlated by default.

6. Tap **Add to Customer** to supplement a Historical Test record sheet to an existing customer account, or add a new associated

account with the test vehicle record. See *Customer Info* on page 102 for more information.

7. Tap **Done** to save the updated record sheet, or tap **Cancel** to exit without saving.

9 Settings

Selecting Settings application opens a setup screen to adjust the default setting and view information about the CR MAX system. There are eight system settings:

- **Unit**
- **Language**
- **Data Log**
- **WIFI**
- **Brightness**
- **Screen Sleep**
- **Vehicle Sorted By**
- **System Settings**
- **Click To Restore Factory Settings**

This section describes the operation procedures for the settings.

9.1 Unit

This option allows you to change the measurement unit for the diagnostic system.

➤ **To adjust the unit setting**

1. Tap the **Settings** application on the CR MAX Job Menu.
2. Tap the **Unit** option on the left column.
3. Select the required measurement unit, Metric or English. A check mark will display on the right of the selected unit.
4. Tap the **Back** button on the top left corner to return to the CR MAX home screen or select another setting.

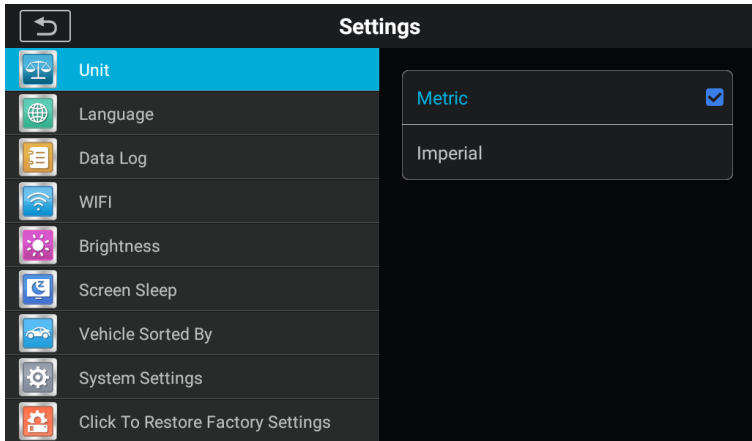

Figure 9-1 Sample Unit Setting Screen

9.2 Language

This option allows you to adjust the display language for the CR MAX system.

➤ **To adjust the language setting**

1. Tap the **Settings** application on the CR MAX Job Menu.
2. Tap the **Language** option on the left column.
3. Jump to the android language Settings interface, select the desired language, long press and drag up to the first bit, language Settings successful.
4. Tap add language to add the desired language.
5. Tap the **Back** button on the bottom left corner to return to the CR MAX settings menu or select another setting.

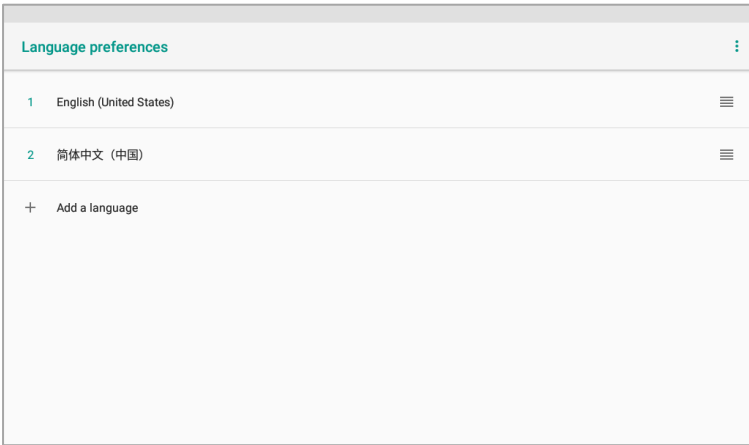

Figure 9-2 Sample Language Setting Screen

9.3 Data log

This option allows you to access the diagnostic system log. It's controlled by a slide switch. Turn on the switch, the diagnostic equipment will automatically backup the diagnostic files of the diagnostic system.

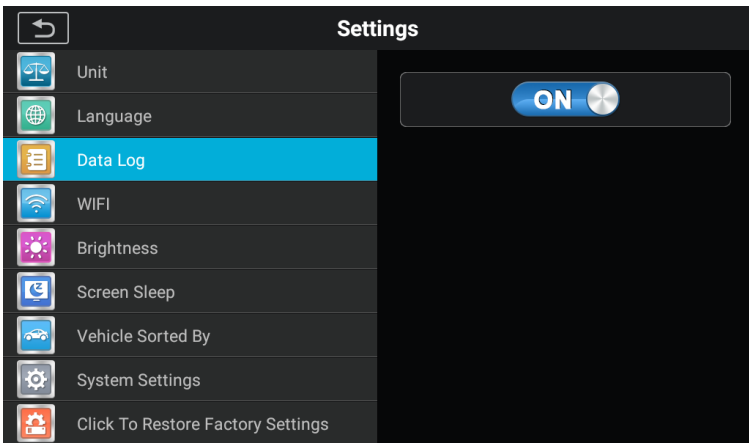

Figure 9-3 Sample Data Log Screen

➤ **To adjust the data log Settings**

1. Tap the **Settings** application on the CR MAX Job Menu.

2. Tap the **Data log** option on the left column.
3. Select the desired state, on or off.
4. Tap the **Back** button on the top left corner to return to the CR MAX home screen or select another setting.

9.4 WIFI

This option allows you to enter the Android background WiFi option settings and select the available network settings.

➤ **To adjust the WIFI setting**

1. Tap the **Settings** application on the CR MAX Job Menu.
2. Tap the **WIFI** option on the left column.
3. Skip to the WiFi Settings interface of Android and select the available network to set up the network.
4. Tap the **Back** button in the bottom left corner to return to the CR MAX settings menu or select another setting.

9.5 Brightness

This option allows you to modify the brightness setting of the diagnostic system.

➤ **To adjust the brightness setting**

1. Tap the **Settings** application on the CR MAX Job Menu.
2. Tap the **brightness** option on the left column.
3. Slide the small points measured on the right by hand to select the appropriate height.
4. Tap the **Back** button in the top left corner to return to the CR MAX home screen or select another setting.

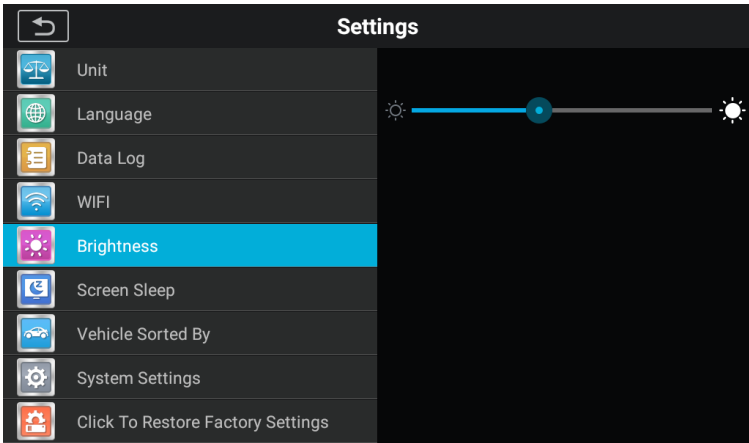

Figure 9-4 Sample brightness Setting Screen

9.6 Screen Sleep

This option allows you to modify the screen lock time setting for the diagnostic system.

➤ **To adjust the Screen Sleep setting**

1. Tap the **Settings** application on the CR MAX Job Menu.
2. Tap the **Screen Sleep** option on the left column.
3. Select the required screen sleep time. There are 8 options, namely 1 minute, 2 minutes, 5 minutes, 10 minutes, 15 minutes, 20 minutes, 30 minutes and 45 minutes. A check mark appears to the right of the selected cell.
4. Tap the **Back** button in the top left corner to return to the CR MAX home screen or select another setting.

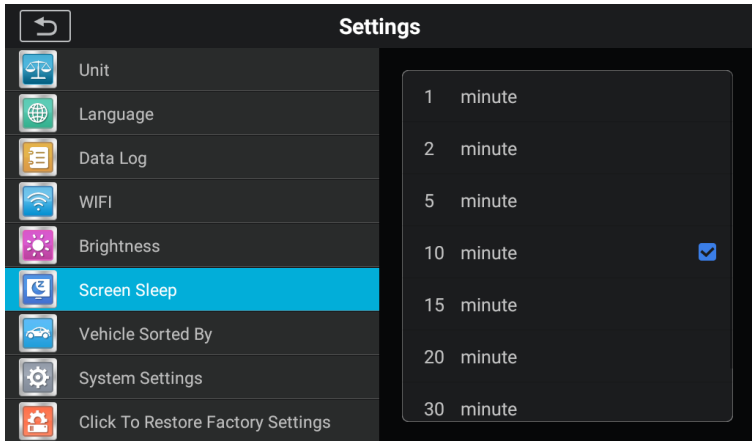

Figure 9-5 Sample screen sleep Setting Screen

9.7 Vehicle Sorted By

This option allows you to modify the vehicle classification settings.

➤ **To adjust the Screen Sleep setting**

1. Tap the **Settings** application on the CR MAX Job Menu.
2. Tap the **Vehicle Sorted By** option on the left column.
3. Select the vehicle classification type you want, alphabetically or by frequency of use. A check mark appears to the right of the selected cell.
4. Tap the **Back** button in the top left corner to return to the CR MAX home screen or select another setting.

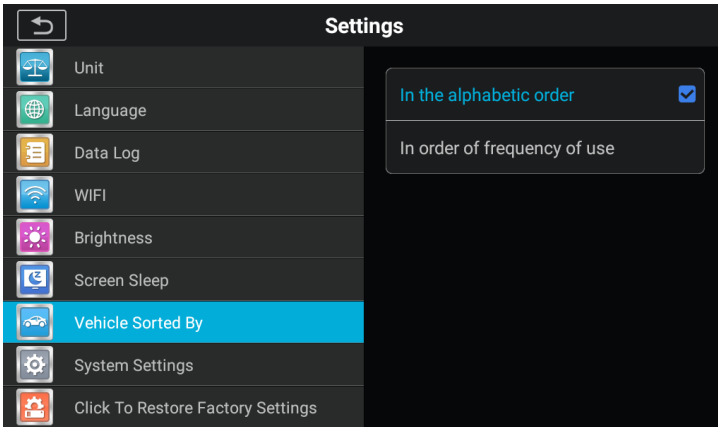

Figure 9-6 Sample Vehicle Sorted By Setting Screen

9.8 System Settings

Access the Android background system setting screen to adjust operating system settings including wireless and network settings, sound and display and system security settings. Android device information is also displayed.

➤ **To enable the App Switcher function**

1. Tap the **Settings** application on the CR MAX Job Menu.
2. Tap the **System settings** option on the left column.
3. Enter the Android background system settings screen and adjust the operating system settings, including setting screen lock, network settings, associated devices, applications and notifications, battery, display, sound, storage, fast bully, security and location information, users and accounts, accessibility, about the system, etc.
4. Tap the **Back** button in the bottom left corner to return to the CR Max **settings** menu or select another setting.

Short pressing the App Switcher icon to open a control panel:

- Tap a specific app shortcut button to be directed to the selected

application screen.

- Long press a specific app shortcut button displays the app menu, on which you can select and change the app shortcut.
- Press and drag the App Switcher icon to another position alongside the edge of the screen.

Refer to Android documentation for information about Android system settings.

9.9 Click To Restore Factory Settings

This option allows you to return to factory settings.

- **To adjust to factory settings**
 1. Tap the **Settings** application on the CR MAX Job Menu.
 2. Tap the **Restore Factory Settings** option on the left column.
 3. This operation will initialize all data in the application settings, including unit, brightness, data switch, screen sleep and vehicle logo sorting.
 4. Tap the **Back** button in the top left corner to return to the CR Max home screen or select another setting.

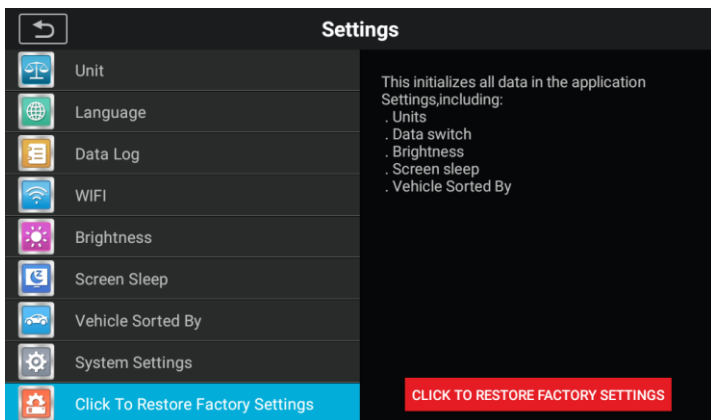

Figure 9-7 Sample Restore Factory Setting Screen

10 Quick Link

The Quick Link application provides access to ICarsoft's official website and to other popular automotive service websites. These sites are invaluable resources of automotive information and repair data and include forums, video training and expert consultation.

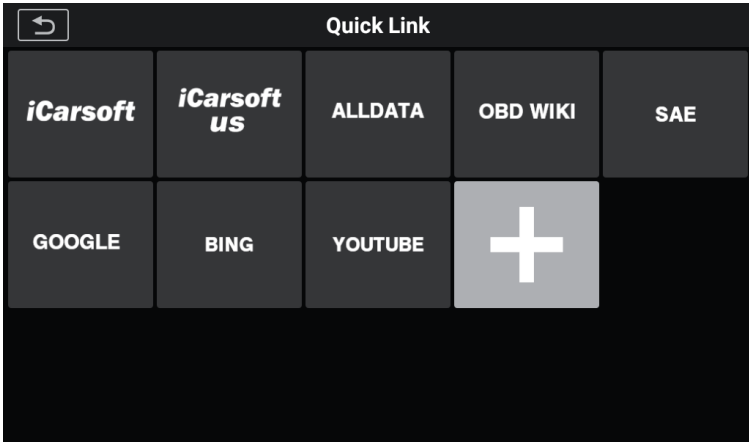

Figure 10-1 Sample Quick Link Screen

➤ **To open a quick link**

3. Tap the **Quick Link** application on the CR MAX Job Menu. The Quick Link application screen displays.
4. Select a website thumbnail from the main section. The Chrome browser is launched and the selected website is opened.
5. Now you can start exploring the website!

11 Fault Code

Fault code allows you to query the fault history and information description according to the model fault code. Slide up and down to select the required model and code.

➤ **To access fault code**

1. Tap the **Fault Code** application on the CR MAX Job Menu. The **Fault Code** application screen displays.
2. Slide up and down to select the required model and code.
3. Tap the lookup button in the upper right corner, and the query results will be displayed in the box below.
4. Tap the history button to view the relevant history.
5. Tap the information button to pop up the description of fault code information

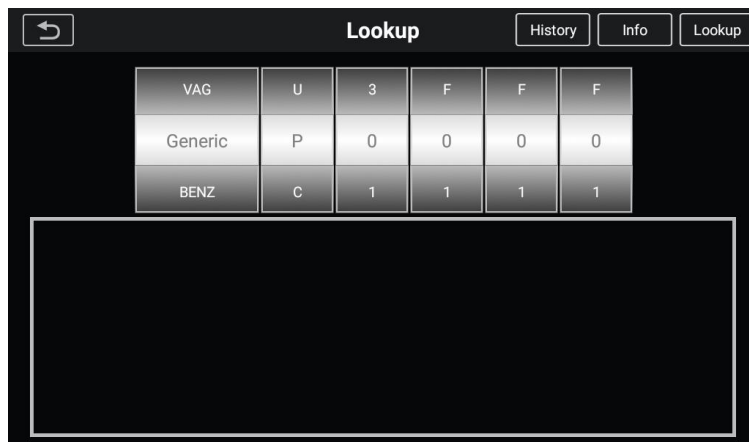

Figure 11-1 Sample Fault Code Screen

12 Support

This application launches the Support platform which synchronizes ICarsoft's on-line service base station with the Display Tablet. In order to synchronize the device to your on-line account, you need to register the product through the Internet when you use it for the first time. The Support application is connected to ICarsoft's service channel and on-line communities which provides the quickest way for problem solutions, allowing you to submit complaints or sent help requests to obtain direct services and supports.

12.1 Account

The " Account" screen displays product information, including product name, device, updates, and service information.

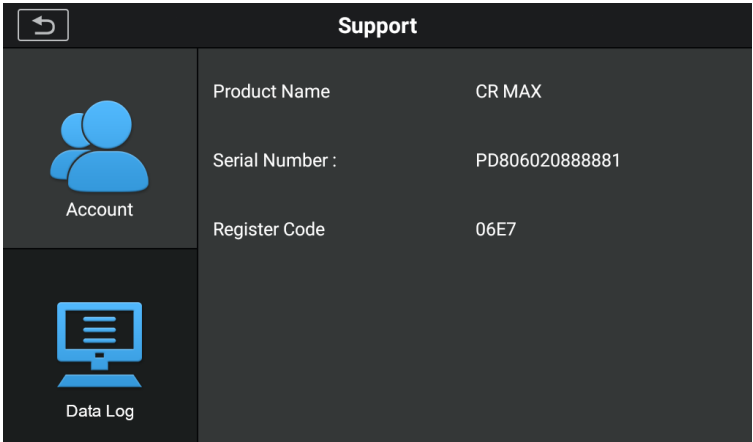

Figure 12-1 Sample Account Screen

12.2 Data Log

The "Data Log" screen displays the data log stored when the diagnostic device performs the diagnosis. When the log switch in the "Settings" option

is turned on, the data log will be automatically stored. Select the check box behind the log, you can delete, you can also provide information feedback.

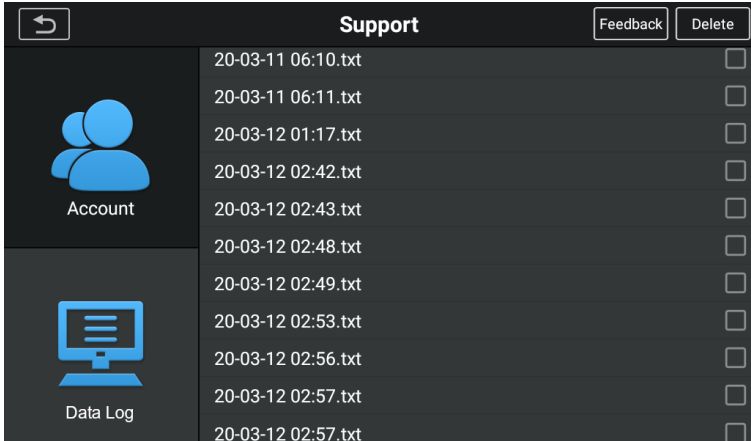

Figure 12-2 Sample Data log Screen 1

1. Select the check box behind the log, you can select multiple logs at the same time, tap the delete button in the upper right corner to delete.
2. Select the check box behind the log, you can select multiple logs at the same time, tap the feedback button in the upper right corner. The interface for information feedback will appear.

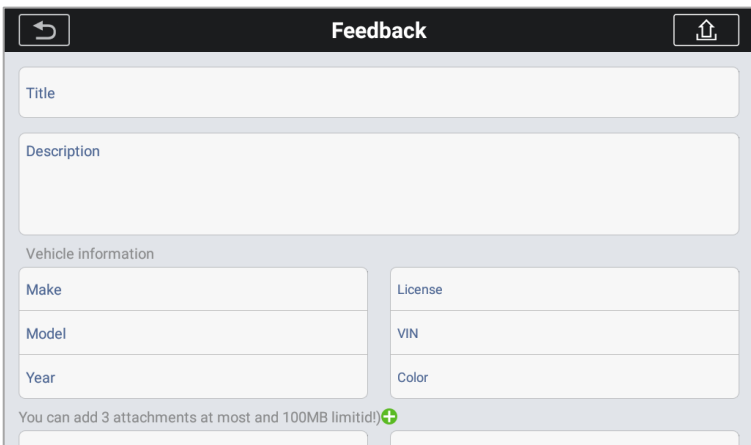



Figure 12-2 Sample Data log Screen 2

- 3 Enter your title, description, vehicle information in the input box, and then tap the "upload" icon to submit your feedback information. You can also tap the  button to add up to 3 pictures to submit together.

13 Uninstall

This section allows you to manage the firmware applications installed on the CR MAX Diagnostics System. Select this section to open a management screen, on which you can check all the available vehicle diagnostic applications.

By clicking on each line of car brand to select the car firmware to be removed, the selected item displays a red flag in the check box on the right. Tap the **Delete** button on the top bar to remove the firmware from the system database.

Uninstall the application screen is navigated through five simple buttons on the top navigation bar, describing each button from left to right:

- **Back Button** – returns to the CR MAX home screen.
- **Diagnostics Button** – press to select firmware for all diagnostic systems.
- **Service Button** – press to select firmware for all service systems.
- **Select All Button** – press to select all the firmware that the page displays.
- **Delete Button** – Remove the selected firmware.

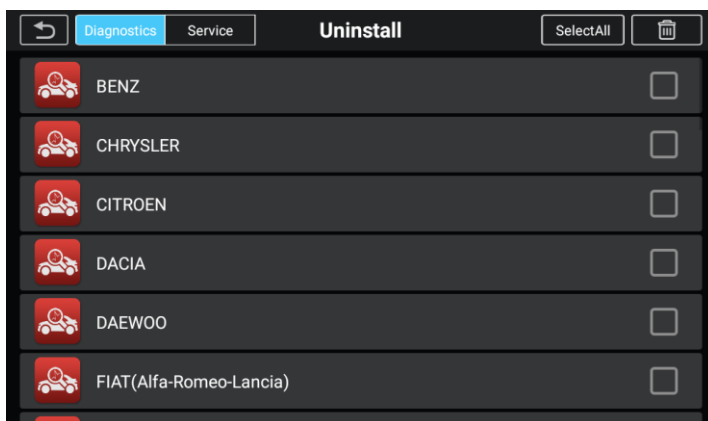

Figure 13-1 Sample Uninstall Screen

14 Remote Desk

The Remote Desk application launches the TeamViewer Quick Support program, a simple, fast and secure remote control screen. Use this application to receive ad-hoc remote support from ICarsoft's support technicians by allowing them to control your CR MAX tablet on their PC via the TeamViewer software.

Make sure the tablet is connected to the Internet before launching the Remote Desk application.

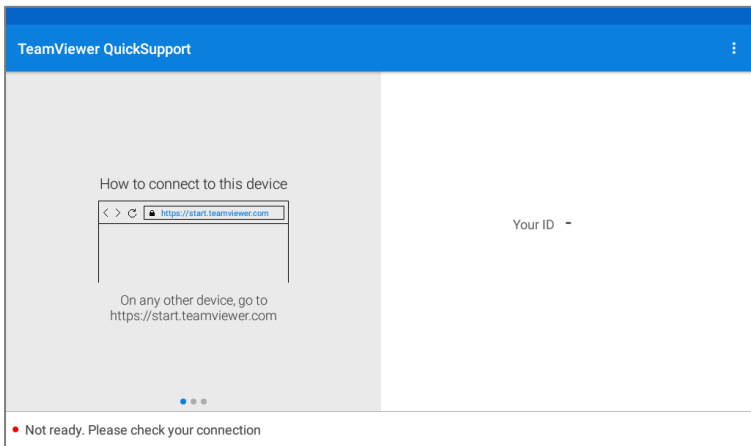

Figure 14-1 Sample Remote Desk Screen

- **To receive remote support from a partner**
 1. Power on the tablet.
 2. Tap the **Remote Desk** application on the CR MAX Job Menu. The TeamViewer screen displays and the device ID is generated and shown.
 3. Your partner must install the Remote Control software to his/her computer by downloading the TeamViewer full version program online (<http://www.teamviewer.com>), and then start the software on his/her computer at the same time, in order to provide support and take control of the Display Tablet remotely.

4. Provide your ID to the partner, and wait for him/her to send you a remote control request.
5. A popup will display to ask for your confirmation to allow remote control on your device.
6. Tap **Allow** to accept, or tap **Deny** to reject.

Refer to the associated TeamViewer documents for additional information.

15 About

The About screen lists the CR MAX's version, hardware, and serial number.

- **To check the CR MAX product information in About**
 1. Tap the **Settings** application on the CR MAX Job Menu.
 2. Tap the **About** option on the left column. The product information screen displays on the right.
 3. Tap the **Back** button on the top left corner to return to the CR MAX home screen, or select another setting option for the system setup after viewing.

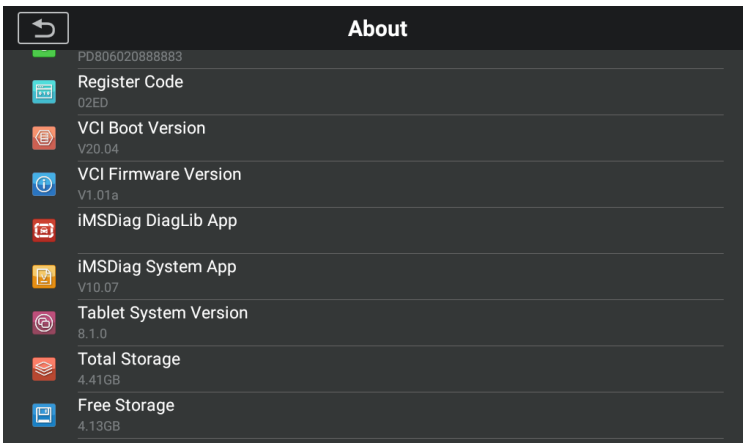

Figure 15-1 Sample About Screen

16 Maintenance and Service

16.1 Maintenance Instructions

The following shows how to maintain your devices, together with precautions to take.

- Use a soft cloth and alcohol or a mild window cleaner to clean the touch screen on the tablet.
- Do not use any abrasive cleansers, detergent, or automotive chemicals to the tablet.
- Only use the device in dry conditions within normal operating temperatures.
- Dry your hands before using the tablet. The touch screen of the tablet may not work if the touch screen is moist, or if you tap the touch screen with wet hands.
- Do not store the devices in humid, dusty or dirty areas.
- Before and after use, check the housing, wiring, and connectors for dirt and damage before and after each use.
- At the end of each work day, wipe the device housing, wiring, and connectors clean with a damp cloth.
- Do not attempt to disassemble your tablet or the VCI unit.
- Take care not drop the device or allow anything heavy to drop on the device.
- Use only authorized battery chargers and accessories. Any malfunction or damage caused by the use of unauthorized battery charger and accessories will void the limited product warranty.
- Ensure that the battery charger does not come in contact with conductive objects.

- Do not operate the tablet next to anything such as microwave oven, cordless phones and some medical or scientific instruments that might interfere with or prevent signal interference.

16.2 Troubleshooting Checklist

A. When the Display Tablet does not work properly:

- Make sure the tablet has been registered online.
- Make sure the system software and diagnostic application software are properly updated.
- Make sure the tablet is connected to the Internet.
- Check all cables, connections, and indicators to see if the signal is being received.

B. When battery life is shorter than usual:

- This may happen when you are in an area with low signal strength. Turn off your device when not in use.

C. When you cannot turn on the tablet:

- Make sure the tablet is connected to a power source or the battery is charged.

D. When you are unable to charge the tablet:

- Your charger maybe out of order. Contact your nearest dealer.
- You may be attempting to use the device in an overly hot/cold temperature. Try changing the charging environment.
- Your device may have not been connected to the charger properly. Check the connector.

NOTE

If your problems persist, please contact ICarsoft's technical support personnel or your local selling agent.

16.3 About Battery Usage

Your tablet is powered by a built-in Lithium-ion Polymer battery. This means that, unlike other forms of battery technology, you can recharge your battery while some charge remains without reducing your tablet's autonomy due to the "battery memory effect" inherent in those technologies.

DANGER

The built-in Lithium-ion Polymer battery is factory replaceable only; incorrect replacement or tampering with the battery pack may cause an explosion. Do not use a damaged battery charger.

- Do not disassemble or open crush, bend or deform, puncture or shred.
- Do not modify or remanufacture, attempt to insert foreign objects into the battery, expose to fire, explosion or other hazard.
- Make sure to use the charger and USB cables only that come together in the package. If you use the other charger and USB cables, you might incur malfunction or failure of the device.
- Only use the charging device that has been qualified with device per the standard. Use of an unqualified battery or charger may present a risk of fire, explosion, leakage, or other hazard.
- Avoid dropping the tablet. If the tablet is dropped, especially on a hard surface, and the user suspects damage, take it to a service center for inspection.
- The closer you are to your network's base station, the longer your tablet usage time because less battery power is consumed for the connection.
- The battery recharging time varies depending on the remaining battery capacity.
- Battery life inevitably shortens over time.

- Since over charging may shorten battery life, remove the tablet from its charger once it is fully charged. Unplug the charger, once charging is complete.
- Leaving the tablet in hot or cold places, especially inside a car in summer or winter, may reduce the capacity and life of the battery. Always keep the battery within normal temperatures.

16.4 Service Procedures

This section introduces information for technical support, repair service, and application for replacement or optional parts.

16.4.1 Technical Support

If you have any question or problem on the operation of the product, please contact us (see the following contact info) or your local distributor.

ICARSOFT USA HQ

- Website: www.icarsoft.us
www.icarsoft.com
- Email: support@icarsoft.com

16.4.2 Repair Service

If it becomes necessary to return your device for repair, please download the repair service form from www.iCarsoft.com, and fill it in. The following information must be included:

- Contact name
- Return address
- Telephone number
- Product name
- Complete description of the problem
- Proof-of-purchase for warranty repairs

- Preferred method of payment for non-warranty repairs

 **NOTE**

For non-warranty repairs, payment can be made with Visa, Master Card, or with approved credit terms.

Send the device to your local agent, please contact your dealer.

16.4.3 Other Services

You can purchase the optional accessories directly from iCarsoft's authorized tool suppliers, and/or your local distributor or agent.

Your purchase order should include the following information:

- Contact information
- Product or part name
- Purchase quantity

17 Compliance Information

FCC Compliance

This device complies with Part 15 of the FCC rules and Industry Canada's license-exempt RSSs. Operation is subject to the following two conditions:

1. This device may not cause harmful interference.
2. This device must accept any interference received, including interference that may cause undesired operation.

WARNING

Changes or modifications not expressly approved by the party responsible for compliance could void the user's authority to operate the equipment.

NOTE

This equipment has been tested and found to comply with the limits for a Class B digital device, pursuant to Part 15 of the FCC Rules. These limits are designed to provide reasonable protection against harmful interference in a residential installation.

This equipment generates uses and can radiate radio frequency energy and, if not installed and used in accordance with the instructions, may cause harmful interference to radio communications. However, there is no guarantee that interference will not occur in a particular installation. If this equipment does cause harmful interference to radio or television reception, which can be determined by turning the equipment off and on, the user is encouraged to try to correct the interference by one or more of the following measures:

- Reorient or relocate the receiving antenna.
- Increase the separation between the equipment and receiver.
- Connect the equipment into an outlet on a circuit different from that to

which the receiver is connected.

-- Consult the dealer or an experienced radio/TV technician for help.

Changes or modifications not expressly approved by the party responsible for compliance could void the user's authority to operate the equipment.

SAR

The radiated output power of this device is below the FCC radio frequency exposure limits. Nevertheless, the device should be used in such a manner that the potential for human contact is minimized during normal operation.

The exposure standard for wireless devices employs a unit of measurement known as the Specific Absorption Rate, or SAR. The SAR limit set by the FCC is 1.6 W/Kg. Tests for SAR are conducted using standard operating positions accepted by the FCC with the device transmitting at its highest certified power level in all tested frequency bands.

Although the SAR is determined at the highest certified power level, the actual SAR level of the device while operating can be well below the maximum value. This is because the device is designed to operate at multiple power levels so as to use only the power required to reach the network. To avoid the possibility of exceeding the FCC radio frequency exposure limits, human proximity to antenna should be minimized.

RF WARNING STATEMENT

The device has been evaluated to meet general RF exposure requirement. The device can be used in portable exposure condition without restriction.

The term "IC" before the radio certification number only signifies that IC technical specifications were met.

RoHS COMPLIANCE

This device is declared to be in compliance with the European RoHS Directive 2011/65/EU&2015/863/EU.

CE COMPLIANCE

This product is declared to conform to the essential requirements of the following Directives and carries the CE mark accordingly:

EMC Directive

R&TTE Directive

Low Voltage Directive

18 Warranty

18.1 Limited One Year Warranty

ICarsoft Technology Inc. (the Company) warrants to the original retail purchaser of this CR MAX Diagnostic Device, that should this product or any part thereof during normal consumer usage and conditions, be proven defective in material or workmanship that results in product failure within one (1) year period from the date of purchase, such defect(s) will be repaired, or replaced (with new or rebuilt parts) with Proof of Purchase, at the Company's option, without charge for parts or labor directly related to the defect(s).

The Company shall not be liable for any incidental or consequential damages arising from the use, misuse, or mounting of the device. Some states do not allow limitation on how long an implied warranty lasts, so the above limitations may not apply to you.

This warranty does not apply to:

- a) Products subjected to abnormal use or conditions, accident, mishandling, neglect, unauthorized alteration, misuse, improper installation or repair or improper storage;
- b) Products whose mechanical serial number or electronic serial number has been removed, altered or defaced;
- c) Damage from exposure to excessive temperatures or extreme environmental conditions;
- d) Damage resulting from connection to, or use of any accessory or other product not approved or authorized by the Company;
- e) Defects in appearance, cosmetic, decorative or structural items such as framing and non-operative parts.
- f) Products damaged from external causes such as fire, dirt, sand,

battery leakage, blown fuse, theft or improper usage of any electrical source.

! **IMPORTANT**

All contents of the product may be deleted during the process of repair. You should create a back-up copy of any contents of your product before delivering the product for warranty service.

iCarsoft Technology Inc.

www.icarsoft.us

www.icarsoft.com

All Rights Reserved